



Auxiliary Light Mounting Bracket BMW R1250GSA '19- LAH.07.11101



Thank you for choosing DENALI

We know you would rather be riding your bike than wrenching on it, so we go the extra mile to make sure our instructions are clear and as easy to understand as possible. If you have any questions, comments, or suggestions don't hesitate to give our gear experts a call at 401.360.2550 or visit WWW.DENALIELECTRONICS.COM

Please Read Before Installing

DENALI products should always be installed by a qualified motorcycle technician. If you are unsure of your ability to properly install a product, please have the product installed by your local motorcycle dealer. DENALI takes no responsibility for damages caused by improper installation. **Caution:** When installing electronics it is extremely important to pay close attention to how wires are routed, especially when mounting products to the front fender, front forks, or fairing of your motorcycle. Always be sure to turn the handlebars fully left, fully right, and fully compress the suspension to ensure the wires will not bind and have enough slack for your motorcycle to operate properly.

Installation Tips

We strongly recommend using medium strength liquid thread locker on all screws, nuts, and bolts. It is also important to ensure that all hardware is tightened to the proper torque specifications as listed in your owner's manual. For included accessory hardware please refer to the default torque specifications provided below. Inspect all hardware after the first 30 miles to ensure proper torque specifications are maintained.

Bolt Size	in-lbs	ft-lbs	Nm
M3	10.0 in-lbs	-	1.0 Nm
M4	23.0 in-lbs	-	2.5 Nm
M5	44.5 in-lbs	3.5 ft-lbs	5.0 Nm
M6	78.0 in-lbs	6.5 ft-lbs	9.0 Nm
M8	-	13.5 ft-lbs	18.0 Nm
M10	-	30.0 ft-lbs	41.0 Nm
M12	-	52.0 ft-lbs	71.0 Nm

Hardware Sizing Guide

Not sure what size bolt you have? Use this ruler to measure screws, bolts, spacers, etc. Remember, the length of a screw or bolt is measured from the start of the "mounting surface" to the end of the screw, so only include the screw head when measuring countersunk screws.

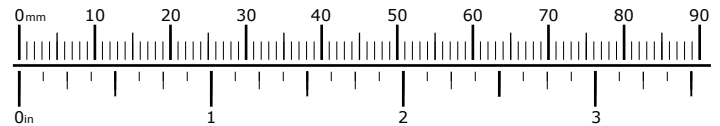

What's In The Box?

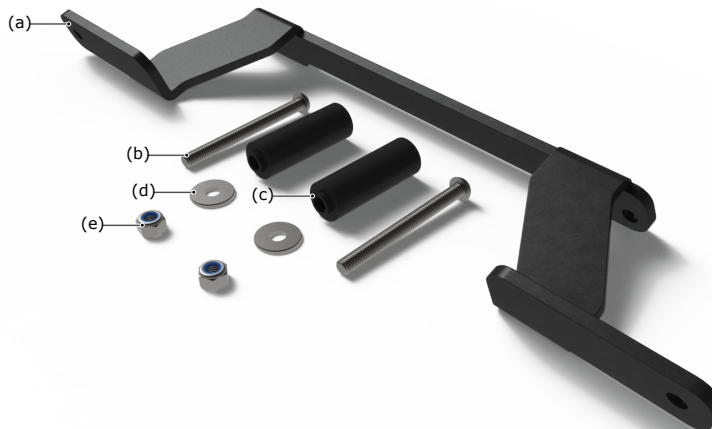

Kit Contents

- (a) Mounting Bracket.....Qty 1
- (b) M8x85 ISO 7380.....Qty 2
- (c) Machined Spacer.....Qty 2
- (d) M8 Washer DIN 9021.....Qty 2
- (e) M8 Nut DIN 985.....Qty 2

Tools Required: 13mm Wrench, 5mm Allen Key, T-25 Torx Bit

1. Accessing The Mounting Location

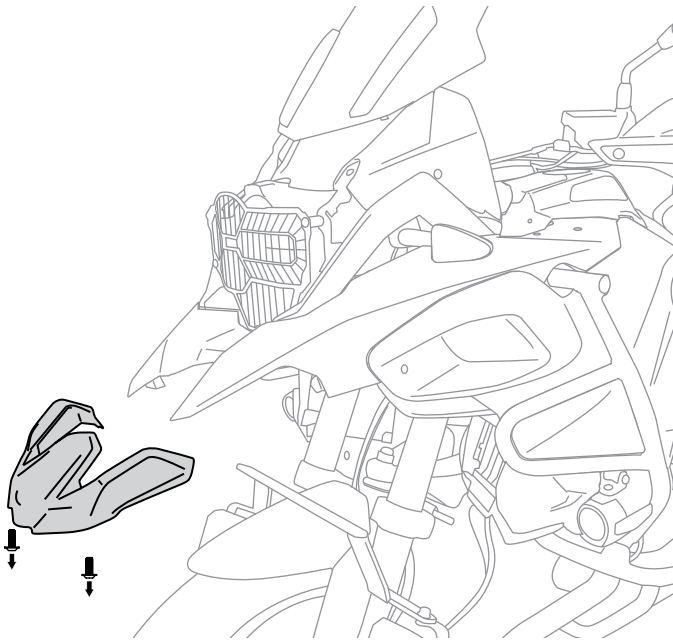

1.1 - Removing The Upper Fender

Step One: Remove the two OEM screws from the under side of the upper fender.

Step Two: Remove the upper fender panel from the motorcycle.

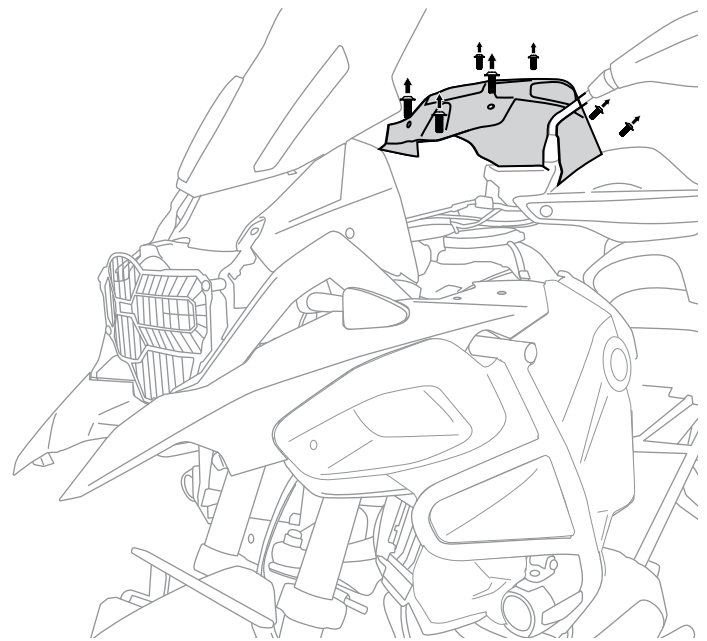

1.2 - Removing The Tank Cover

Step One: Remove the seven OEM screws securing the tank cover to the gas tank.

Note: Two of the OEM screws are located inside the small storage compartment located on top of the tank.

Step Two: Remove the tank cover from the motorcycle.

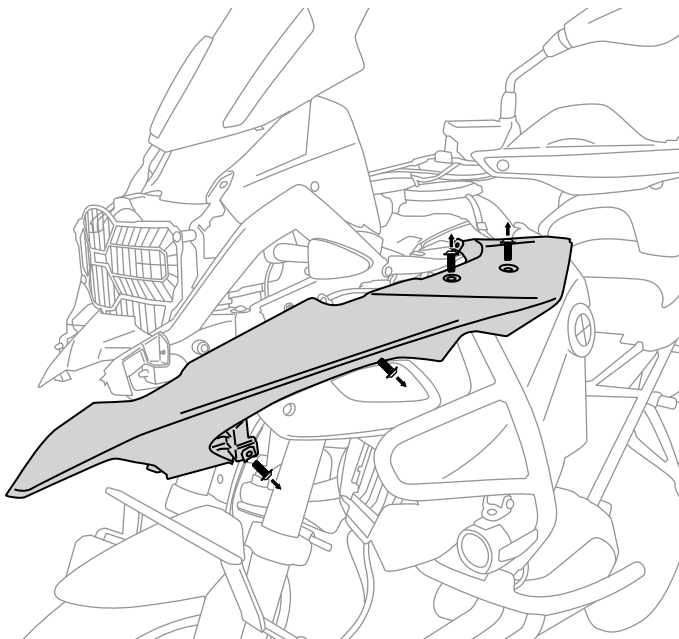

2.1 - Removing The Left Side Fairing

Step One: Remove the four OEM screws securing the left side fairing panel to the motorcycle.

Step Two: Remove the left side fairing from the motorcycle.

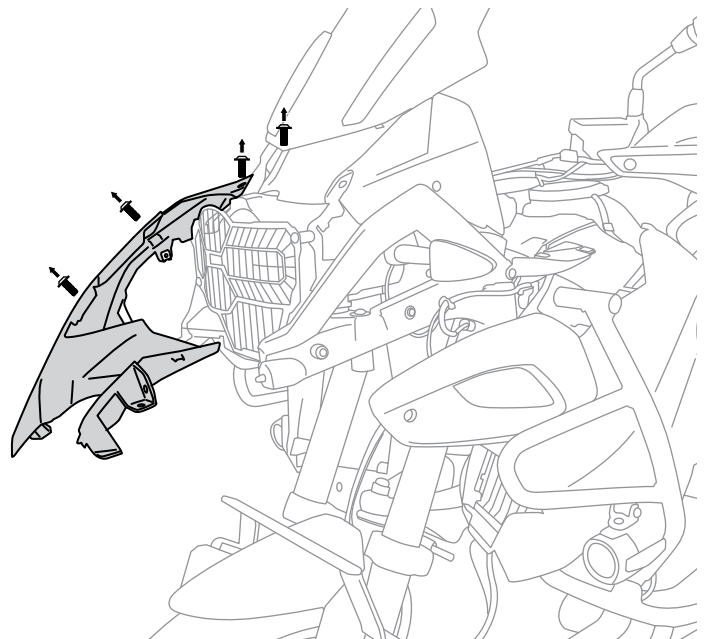

2.2 - Removing the Right Side Fairing

Step One: Remove the four OEM screws securing the right side fairing panel to the motorcycle.

Step Two: Remove the right side fairing from the motorcycle.

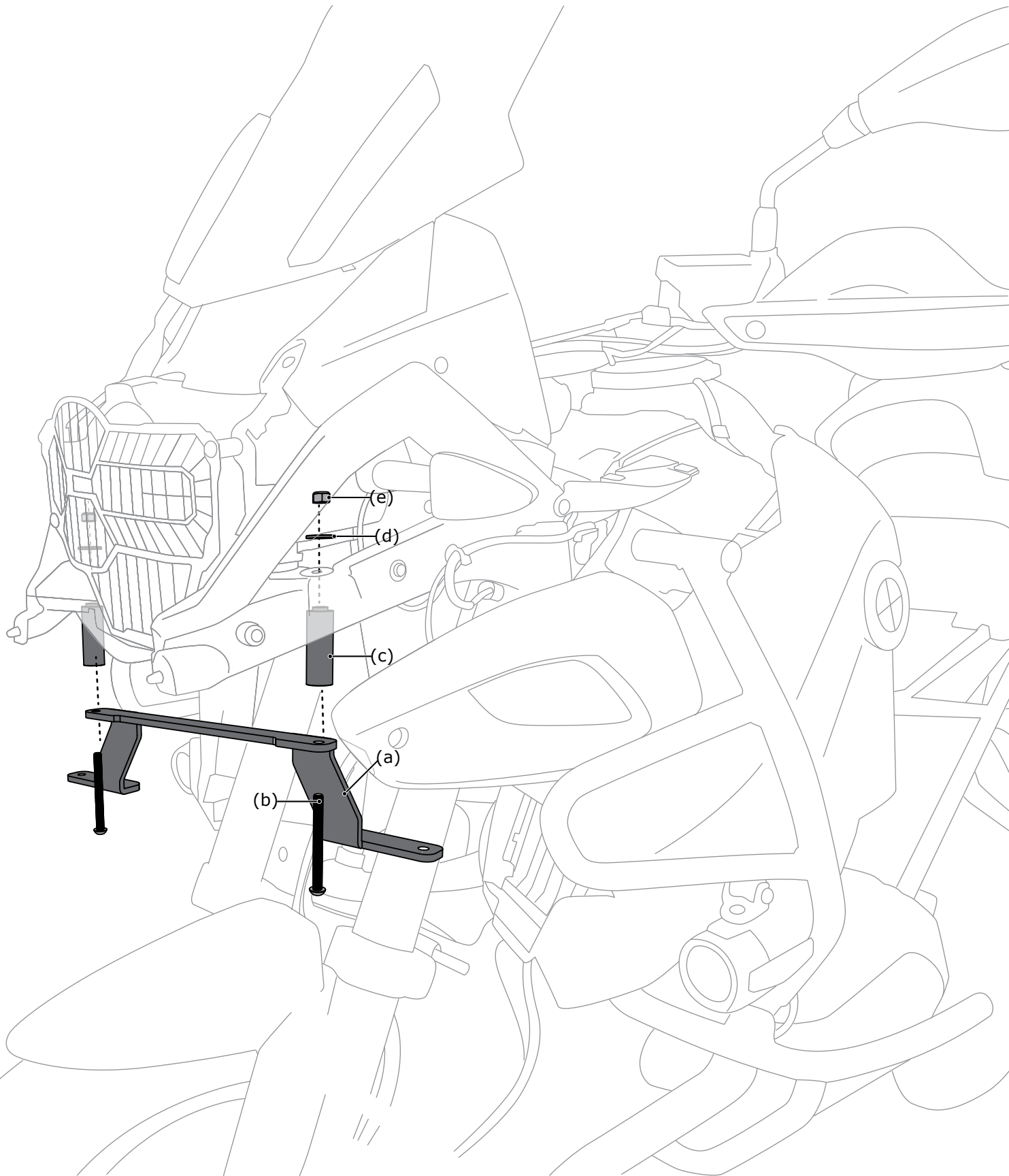

2.1 - Installing the Bracket

Step One: Pass one of the M8 bolts (b) through one of the mounting holes on the bracket (a) and place a machined spacer (c) over the threads of the bolt.

Step Two: Position the bracket into place and use a washer (d) and nut (e) to secure the assembly to the motorcycle. Do not fully tighten at this time.

Step Three: Repeat steps *one* and *two* using the remaining hardware and the other mounting hole on the bracket (a).

Step Four: Mount the light pods to the bracket using the hardware included with the light pod.

2.2 - Before You Ride

Before operating the motorcycle, turn the handlebars fully left, fully right, and fully compress the suspension. Confirm that the lights do not interfere with operation and that the wires have enough slack to account for all suspension and steering movement.