



SCHUBERTH



SC2

**MOTORCYCLE BLUETOOTH®
COMMUNICATION SYSTEM
WITH MESH INTERCOM™**

USER'S GUIDE

TABLE OF CONTENTS

1.	ABOUT THE SC2	6
1.1	Product Details	6
1.1.1	SC2	6
1.1.2	SC2 Remote Control	6
1.2	Package Contents	7
1.3	Optional Accessories	7
2.	INSTALLING THE HEADSET ON YOUR HELMET	8
2.1	Installing the SC2 Remote Control	8
2.2	Installing the SC2	8
2.3	Removing the SC2	10
2.4	Installing the Microphone	11
3.	GETTING STARTED	12
3.1	Legend	12
3.2	Downloadable Software	12
3.2.1	SCHUBERTH SC2 App	12
3.2.2	SCHUBERTH Device Manager	12
3.3	Powering On and Off	13
3.3.1	SC2 Powering On and Off	13
3.3.2	SC2 Remote Control Powering On and Off	13
3.4	Charging the SC2	14
3.5	Replacing the Battery	14
3.6	Checking the Battery Level	15
3.7	Volume Adjustment	15
4.	PAIRING THE HEADSET WITH OTHER BLUETOOTH DEVICES	16
4.1	Phone Pairing	16
4.2	Second Mobile Phone Pairing - Second Mobile Phone, GPS, and SR10	17

4.3	Advanced Selective Pairing: Hands-Free or A2DP Stereo	18
4.3.1	Phone Selective Pairing - Hands-Free Profile	18
4.3.2	Media Selective Pairing - A2DP Profile	18
4.4	GPS Pairing	19
5.	MOBILE PHONE USAGE	20
5.1	Making and Answering Calls	20
5.2	Siri and Google Assistant	20
5.3	Speed Dialing	21
5.3.1	Assigning Speed Dial Presets	21
5.3.2	Using Speed Dial Presets	21
6.	STEREO MUSIC	22
6.1	Bluetooth Stereo Music	22
6.2	Music Sharing	22
6.2.1	Bluetooth Intercom Music Sharing	23
6.2.2	Mesh Intercom Music Sharing	23
7.	MESH INTERCOM	24
7.1	What is Mesh Intercom?	24
7.1.1	Open Mesh	25
7.1.2	Group Mesh	26
7.2	Starting Mesh Intercom	26
7.3	Using the Mesh in Open Mesh	27
7.3.1	Channel Setting (Default: Channel 1)	27
7.4	Using Mesh in Group Mesh	28
7.4.1	Creating a Group Mesh	28
7.4.2	Joining an Existing Group Mesh	29
7.5	Enable/Disable Mic (Default: Enable)	30
7.6	Toggling Open Mesh/Group Mesh	30
7.7	Reset Mesh	30

8.	BLUETOOTH INTERCOM	31
8.1	Intercom Pairing	31
8.1.1	Using the Smart Intercom Pairing (SIP)	31
8.1.2	Using the Button	32
8.2	Last-Come, First-Served	32
8.3	Two-Way Intercom	33
8.4	Multi-Way Intercom	34
8.4.1	Starting a Three-Way Intercom Conference	34
8.4.2	Starting a Four-Way Intercom Conference	35
8.4.3	Ending Multi-Way Intercom	35
8.5	Three-Way Conference Phone Call with Intercom Users	36
8.6	Group Intercom	37
8.7	Mesh Intercom Conference with Bluetooth Intercom Participant	37
8.8	Universal Intercom	39
8.9	Mesh Intercom Conference with Two-way Universal Intercom Participant	40
9.	USING THE FM RADIO	41
9.1	FM Radio On/Off	41
9.2	Seek and Save Radio Stations	41
9.3	Scan and Save Radio Stations	42
9.4	Navigating Preset Stations	43
9.5	Temporary Station Preset	43
9.6	Region Selection	43
10.	VOICE COMMAND	44
11.	FUNCTION PRIORITY	46
11.1	Function Priority	46

12. CONFIGURATION SETTING	47
12.1 Headset Configuration Setting	47
12.1.1 Delete All Pairings	47
12.2 Software Configuration Setting	48
12.2.1 Speed Dial	48
12.2.2 Headset Language	48
12.2.3 Audio Equalizer (Default: Off)	48
12.2.4 VOX Phone (Default: Enable)	48
12.2.5 VOX Intercom (Default: Disable)	48
12.2.6 VOX Sensitivity (Default: 3)	49
12.2.7 Bluetooth Intercom Audio Multitasking (Default: Disabled)	49
12.2.8 Intercom-Audio Overlay Sensitivity (Default: 3)	49
12.2.9 Audio Overlay Volume Management (Default: Disable)	49
12.2.10 HD Intercom (Default: Enable)	50
12.2.11 HD Voice (Default: Enable)	50
12.2.12 Smart Volume Control (Default: Disable)	50
12.2.13 Sidetone (Default: Disable)	50
12.2.14 Voice Prompt (Default: Enable)	51
12.2.15 RDS AF Setting (Default: Disable)	51
12.2.16 FM Station Guide (Default: Enable)	51
12.2.17 Advanced Noise Control™ (Default: Enable)	51
13. TROUBLESHOOTING	52
13.1 SC2 Factory Reset	52
13.2 SC2 Remote Control Factory Reset	52
13.3 Remote Control Pairing	52
13.4 SC2 Fault Reset	53

1. ABOUT THE SC2

1.1 Product Details

1.1.1 SC2

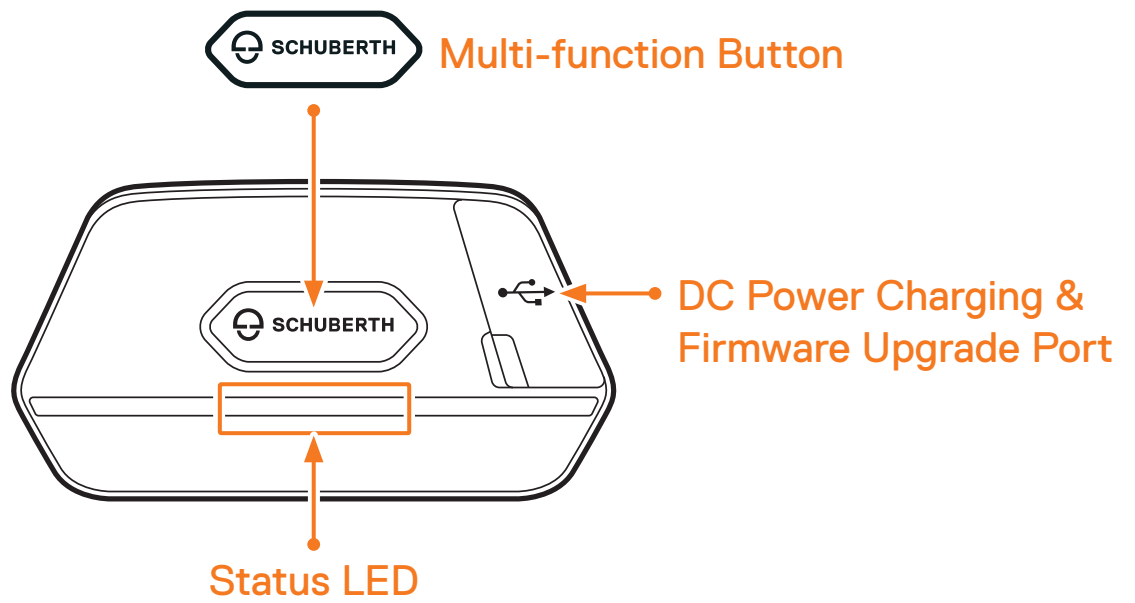

1.1.2 SC2 Remote Control

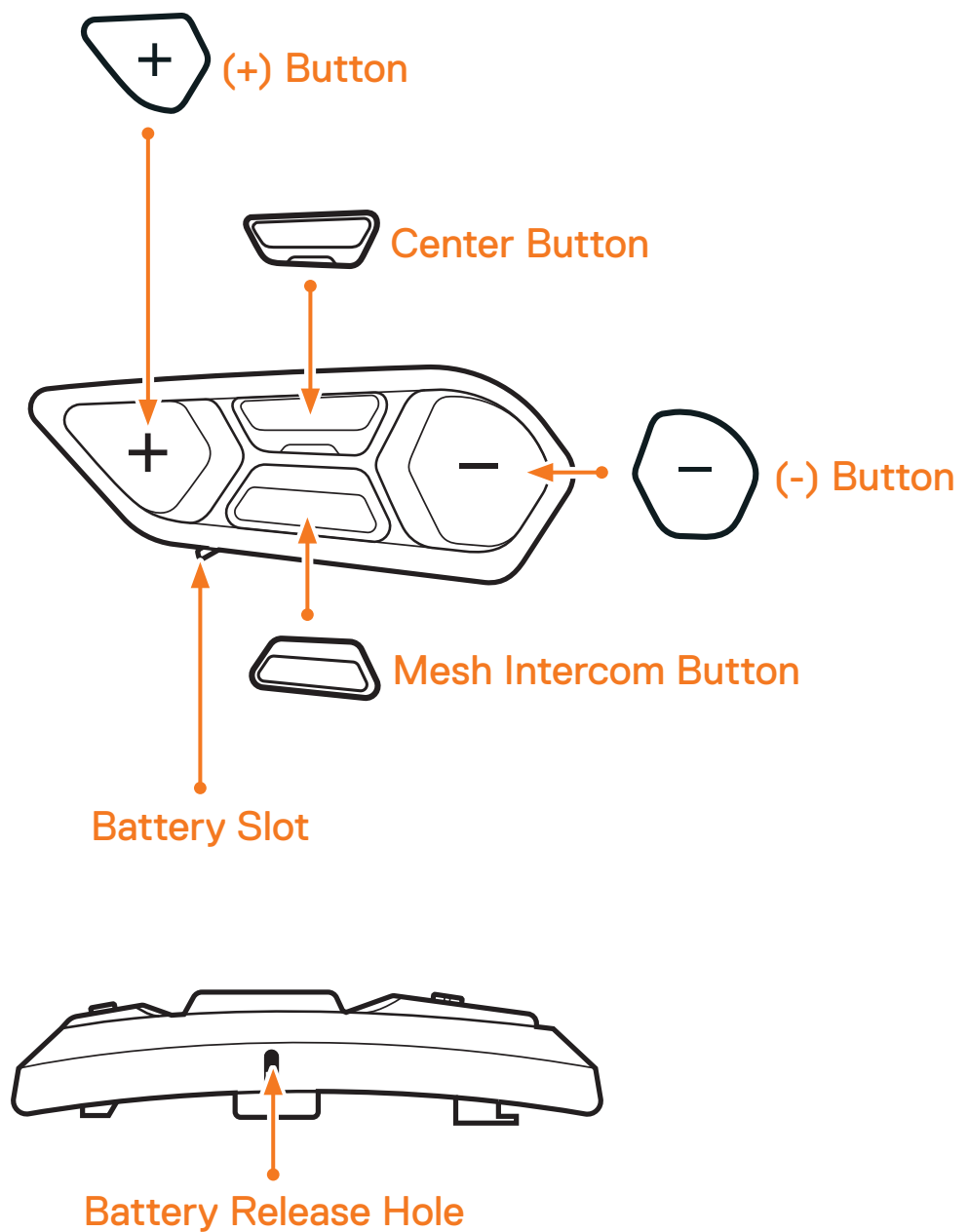

1.2 Package Contents



SC2

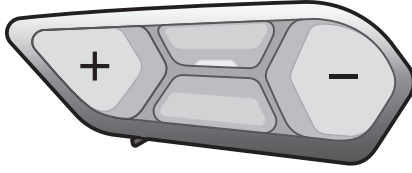

SC2 Remote Control



SC2 HD Boom Microphone

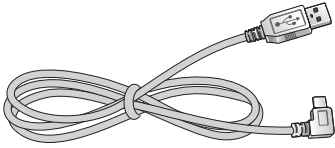

USB-C Power & Data Cable

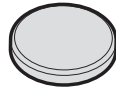

Coin Battery

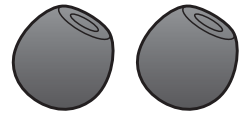

Foam cover for SC2 HD Boom Microphone (2)

1.3 Optional Accessories

Contact SCHUBERTH or your authorized dealer for accessories.

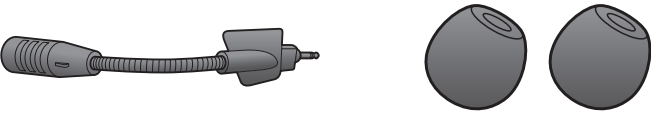
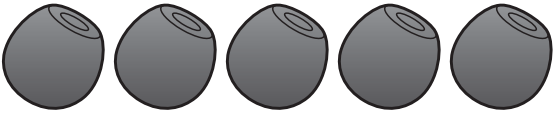
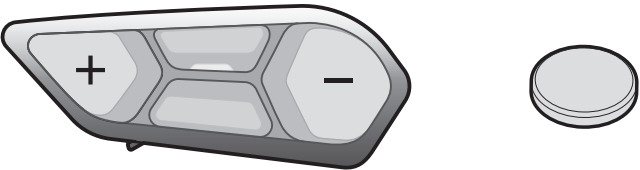
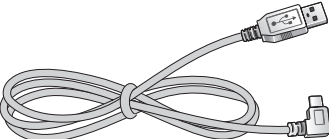
Part Number	Spare Part
9049100370	SC2 HD Boom Microphone with foam cover 
9049100372	Foam cover for SC2 HD Boom Microphone 
9049100374	Remote Control for SC2 
9049100375	USB-C Power & Data Cable 

2. INSTALLING THE HEADSET ON YOUR HELMET

2.1 Installing the SC2 Remote Control

1. Remove the cover for the **SC2 Remote Control** from your helmet.

Cover for the SC2 Remote Control

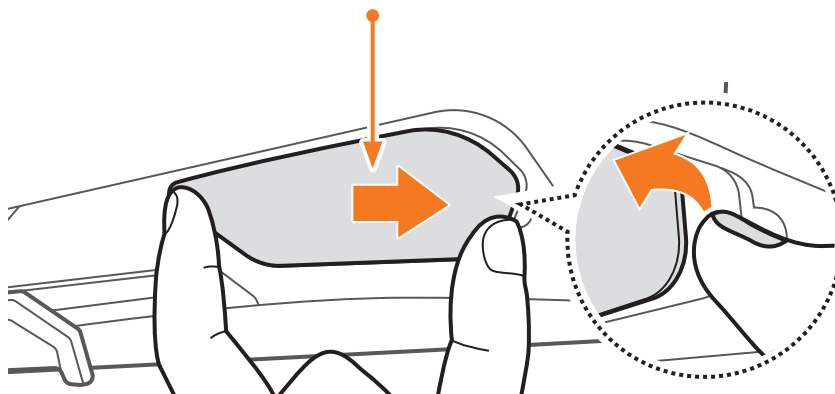

2. Slide and insert the **SC2 Remote Control** onto your helmet.

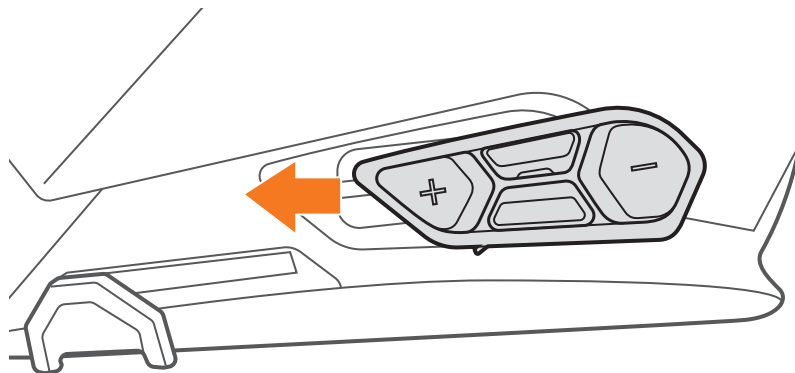

2.2 Installing the SC2

1. Remove the SC2 cover from the helmet by lifting it up with the SC2 Remote Control cover.

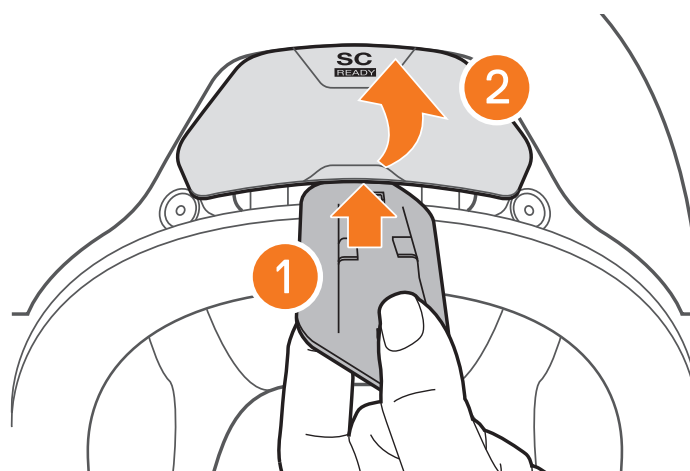

2. Pull out the antenna cable retainer from its original position, and pull out the antenna cables from the upper gap in the space. Then, connect the SC2's antenna cables and the helmet's antenna cables correctly.

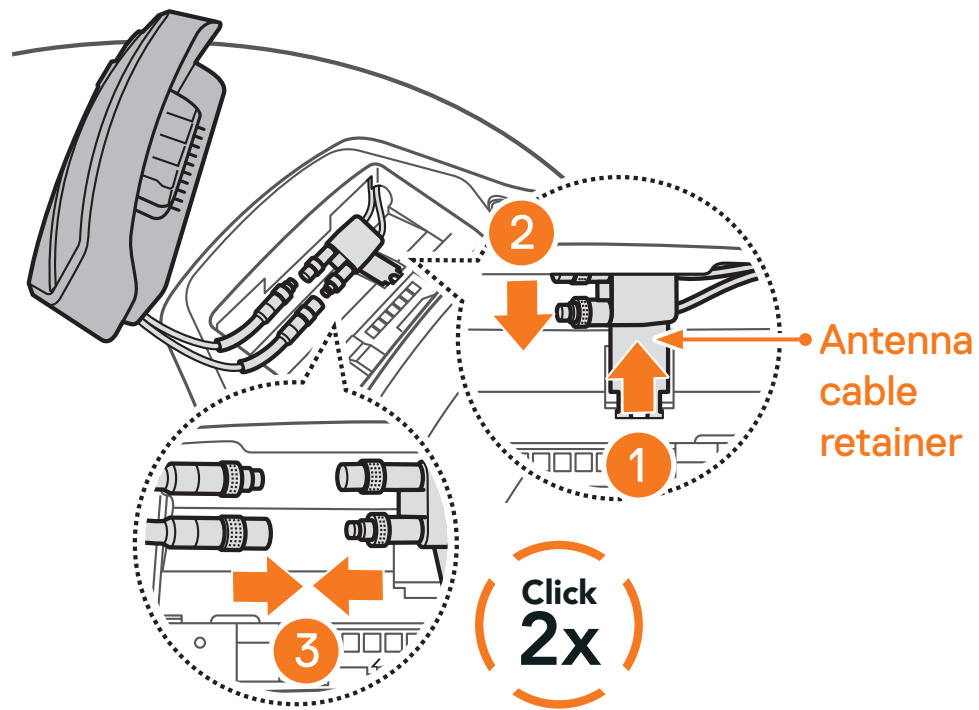

3. Put the antenna cable retainer back into its original position, and put the connected cables into the upper gap in the space.

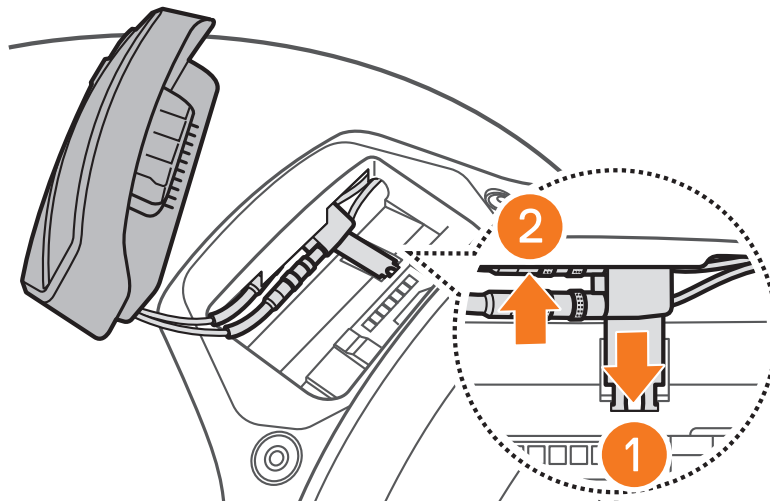

Note: Make sure that the antenna cable retainer and the connected cables are positioned correctly before installing the **SC2**. If not, the cables may be damaged or interference may occur.

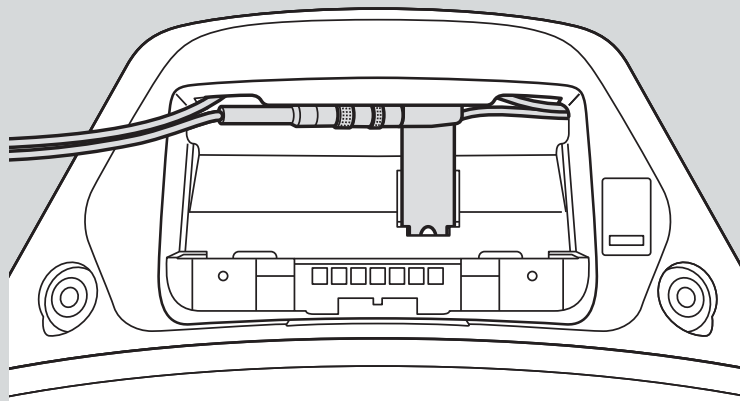

4. Install the **SC2** into the helmet.

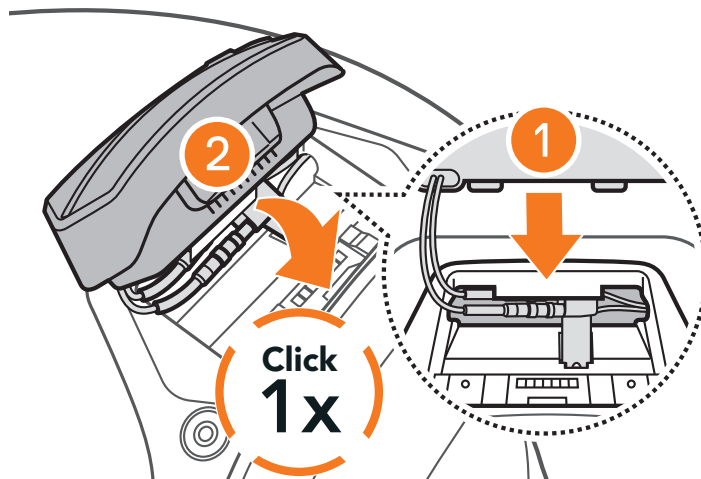

2.3 Removing the SC2

1. Remove the installed **SC2** from the helmet by lifting it up with the SC2 Remote Control cover.

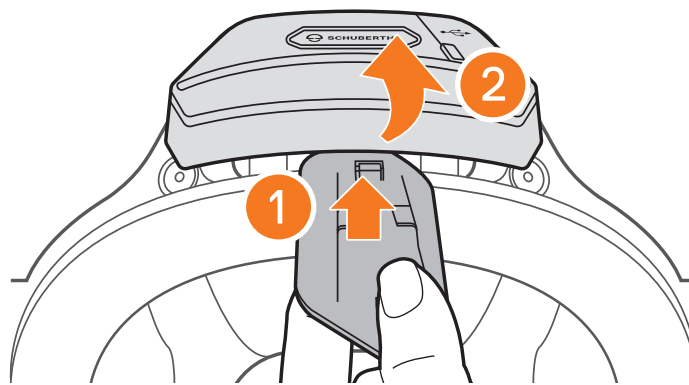

2. Pull the antenna cable retainer out from its original position, and pull out the connected cables from the upper gap in the space. Then, disconnect the cables correctly.

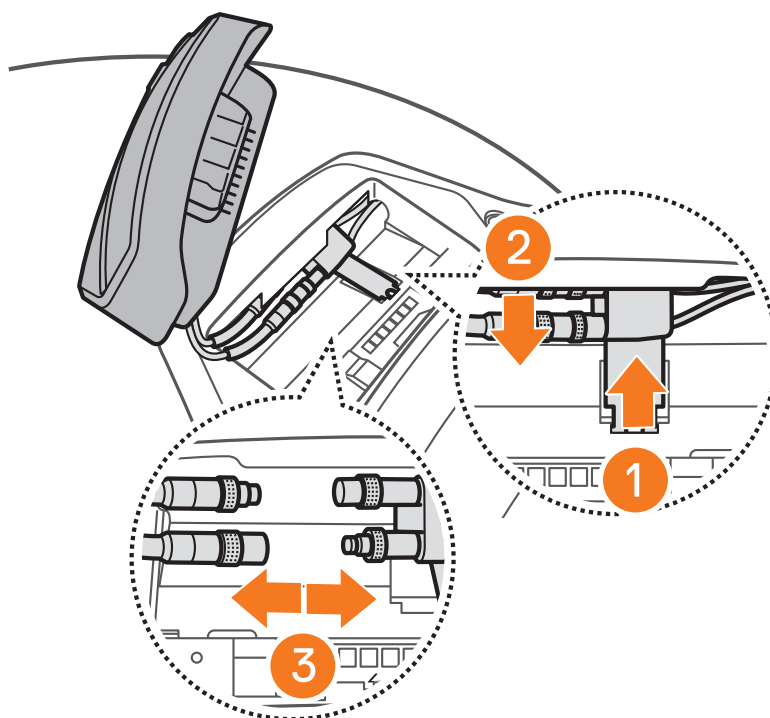

Note: When you need to un-plug the connectors, please wiggle and pull them. It will help the connector connection be released more easily.

- Put the antenna cable retainer back into its original position, and put the helmet's cables into the upper gap in the space.

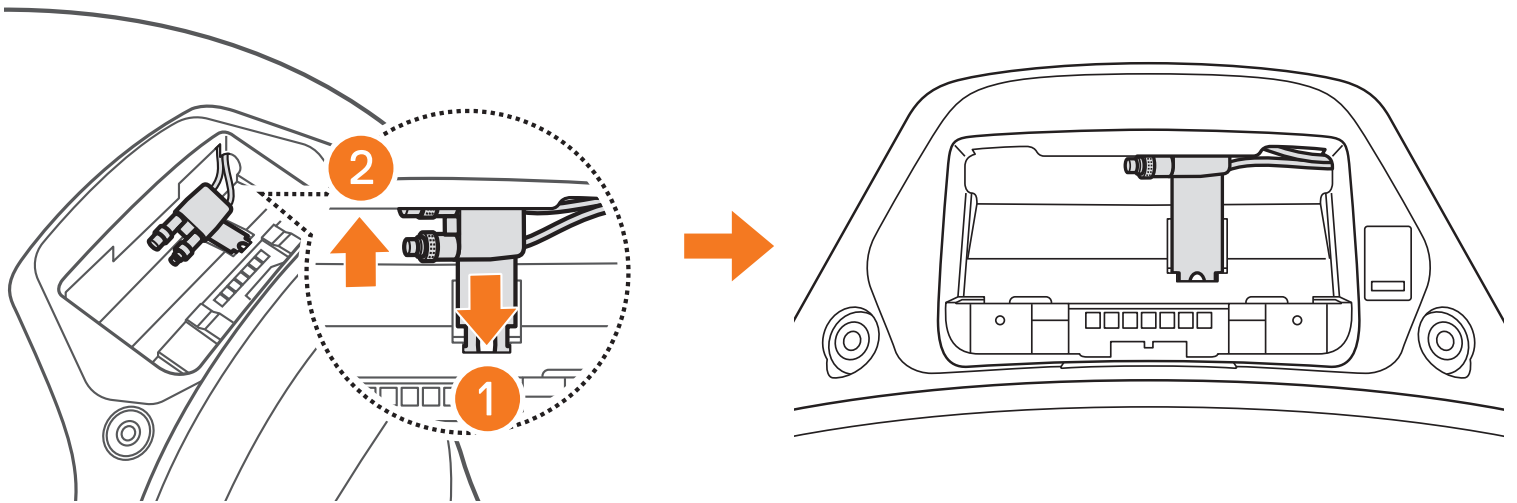

2.4 Installing the Microphone

- Remove the microphone rubber cap as shown in the illustration to install the microphone.

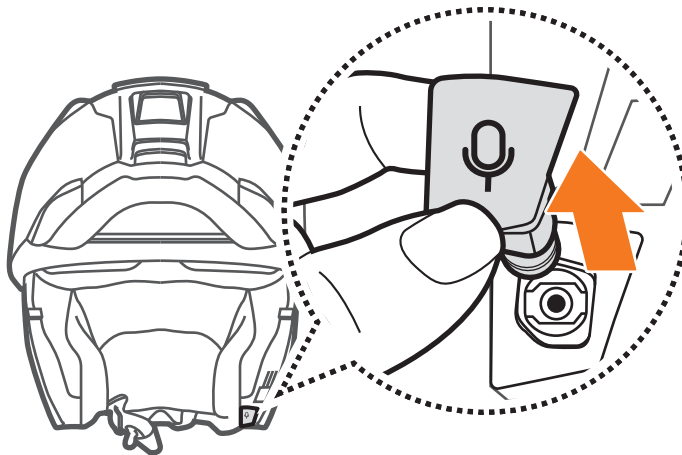

- Install the microphone by pressing firmly on the area marked with the orange circle.

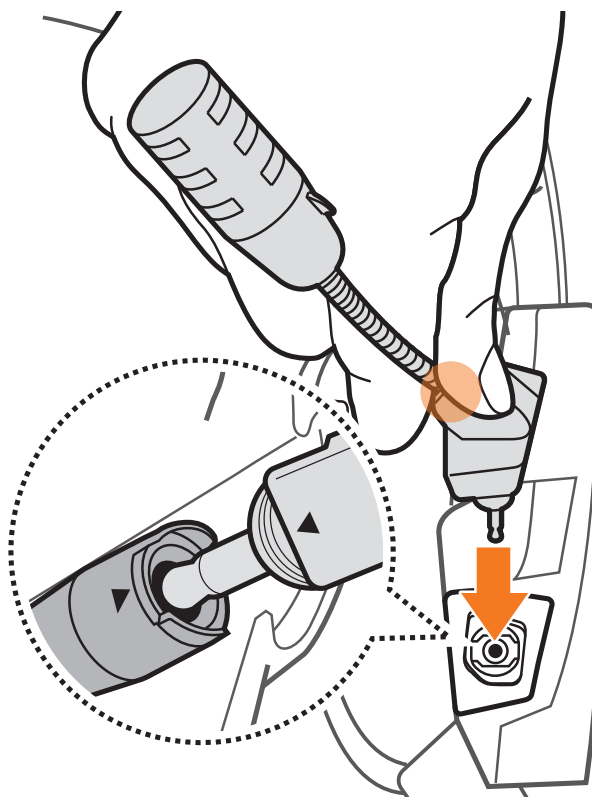

3. GETTING STARTED

3.1 Legend

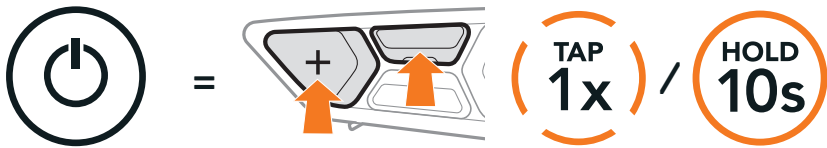

Function = Button(s) to **tap** the specified amount of number of times or **press and hold** for the specified amount of time.



“Hello”

Audible prompt

3.2 Downloadable Software

3.2.1 SCHUBERTH SC2 App



SCHUBERTH SC2 APP

By simply pairing your phone with your headset, you can use the **SCHUBERTH SC2 App** for quicker and easier set up and management.

- ◆ App functions: Mesh Intercom, Bluetooth Intercom, Music, Device settings, Language settings
- ◆ Download
 - Android: Google Play Store > **SCHUBERTH SC2**
 - iOS: App Store > **SCHUBERTH SC2**

3.2.2 SCHUBERTH Device Manager

The **SCHUBERTH Device Manager** allows you to **upgrade the firmware** and **configure its settings** directly from your PC or Apple computer.

Download the **SCHUBERTH Device Manager** from oem.sena.com/schuberth/.

Click Here to Visit oem.sena.com/schuberth/

3.3 Powering On and Off

3.3.1 SC2 Powering On and Off

To switch on the **SC2**, hold the **Multi-function Button** for **2 seconds**.

To switch off the **SC2**, hold the **Multi-function Button** for **2 seconds** until you hear the double beep.

Powering On/Off



3.3.2 SC2 Remote Control Powering On and Off

- ◆ To begin using the **SC2 Remote Control**, remove the plastic strip from the battery slot.

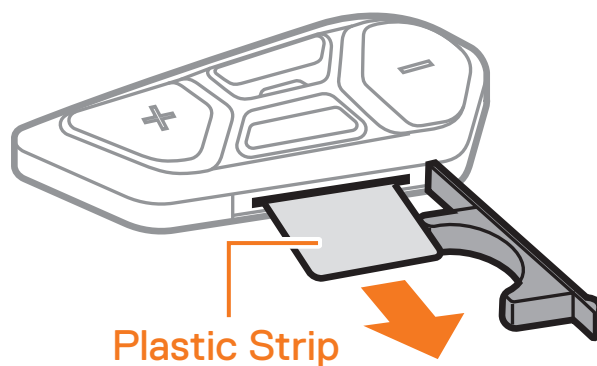

- ◆ Tap the **Center Button**.

Powering On

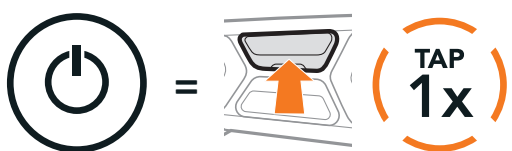

- ◆ Press and hold the **(+) Button** and the **Center Button** for **3 seconds**.

Powering Off

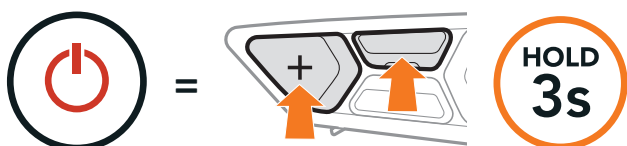

Note: The **SC2** and the **SC2 Remote Control** come paired together. They will automatically connect to each other when the **SC2** and the **SC2 Remote Control** are powered on.

3.4 Charging the SC2

Charging the Headset

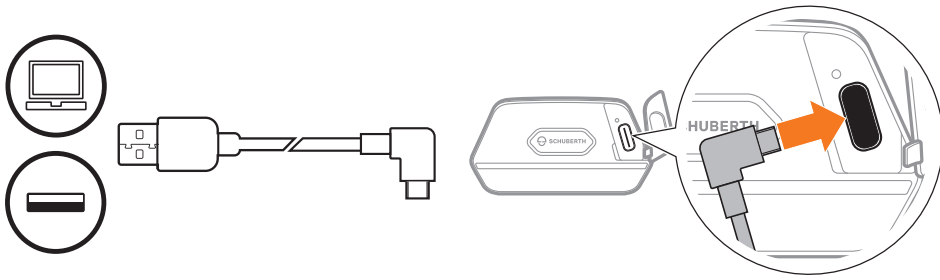

The headset will be fully charged in about 2.5 hours. (The charging time may vary depending on the charging method.)

Note:

- ◆ Please make sure to take off your SC2-installed helmet while charging. The headset automatically turns off during charging.
- ◆ Any 3rd party USB charger can be used with the headset if the charger is approved by either the FCC, CE, or IC.
- ◆ The **SC2** is compatible with 5 V/1 A input USB-charged devices only.

3.5 Replacing the Battery

To replace the discharged battery of the **SC2 Remote Control**, follow the steps below:

1. Prepare a CR2016 Lithium 3 V coin battery for the **SC2 Remote Control**.
2. Open the battery slot's cover.

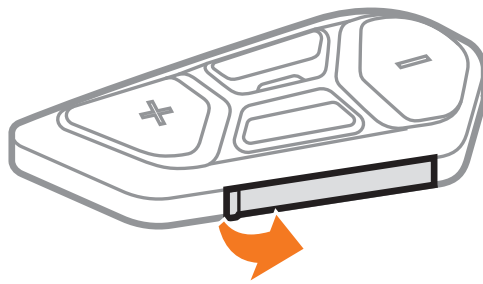

3. Insert a paper clip into the Battery Release Hole. Then, change the discharged battery with the new battery.

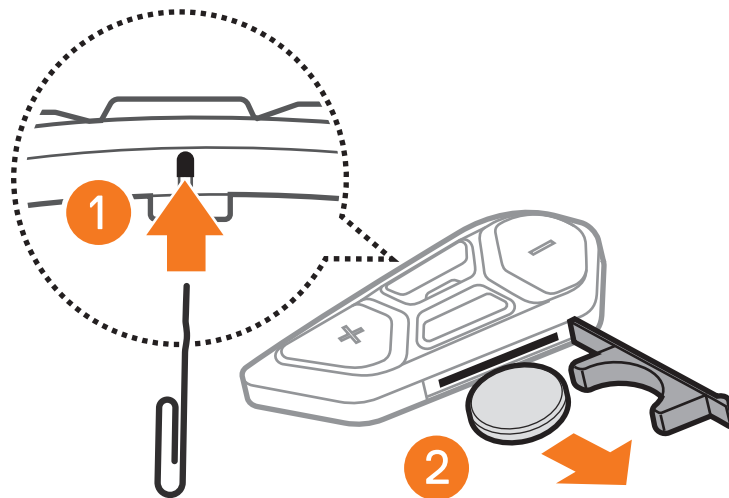

4. Insert the new battery into the battery slot.

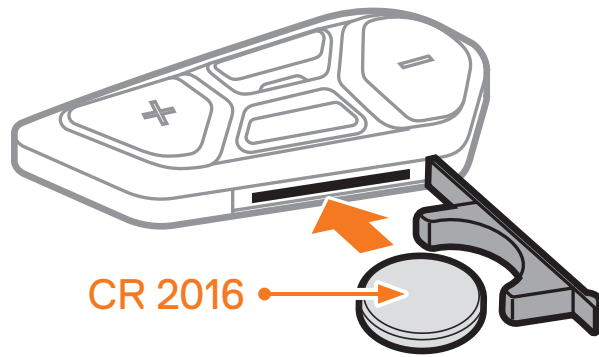

5. Close the battery slot's cover. When closing the cover, insert the cover's two battery guides first.

3.6 Checking the Battery Level

When switching on, the LED flashes red to indicate the charge level.

SC2

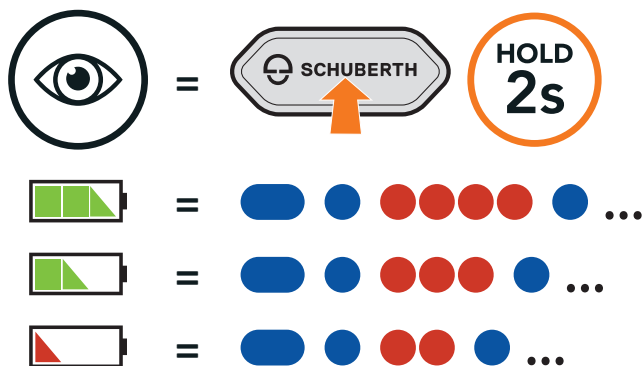

SC2 Remote Control

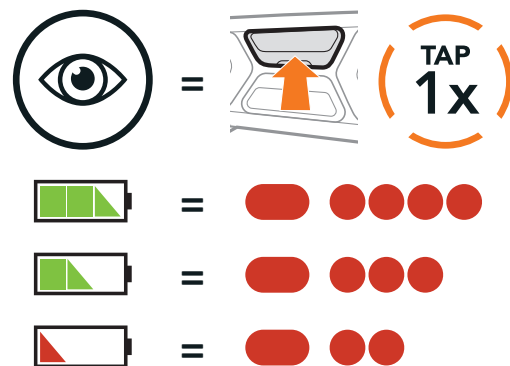

Note: When the SC2's battery is low while in use, you will hear a voice prompt saying "Low battery".

3.7 Volume Adjustment

You can raise or lower the volume by tapping the **(+) Button** or the **(-) Button**. Volume is set and maintained independently at different levels for each audio source (i.e., phone, intercom), even when the headset is rebooted.

Volume Up

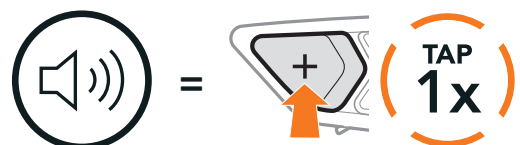

Volume Down



4. PAIRING THE HEADSET WITH OTHER BLUETOOTH DEVICES

When using the headset with other Bluetooth devices for the first time, they will need to be “paired”. This enables them to recognize and communicate with one another whenever they are within range.

The headset can pair with multiple Bluetooth devices such as a mobile phone, GPS, MP3 player, or Sena SR10 Two-Way Radio Adapter via **Mobile Phone Pairing, Second Mobile Phone Pairing, and GPS Pairing**. The headset can also be paired with up to three other SCHUBERTH headsets.

Pairs with up to Three SCHUBERTH Headsets



Also Pairs with:

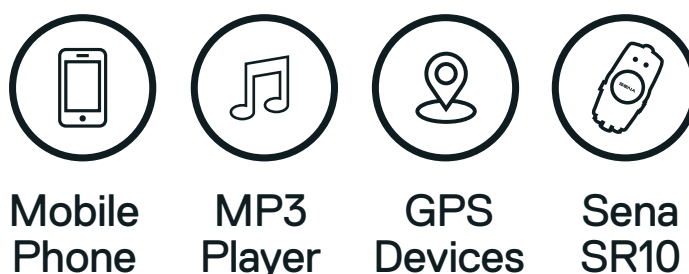

4.1 Phone Pairing

Phone Pairing

1. Press and hold the **Center Button** for **10 seconds**.



2. Tap the **(+) Button**.

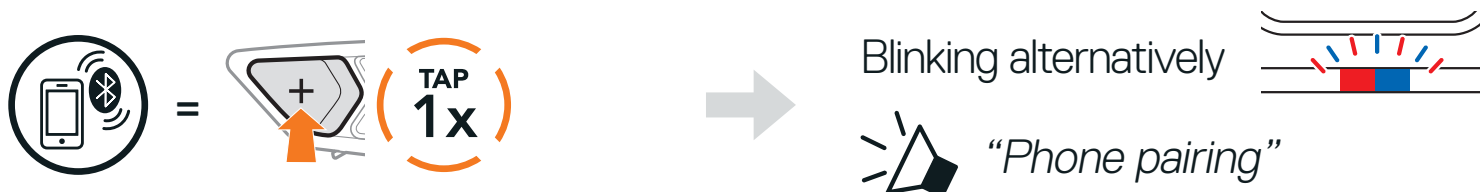

3. With your mobile phone in Bluetooth-pairing mode, select **SC2** in the list of devices detected.

If your mobile phone asks for a PIN, enter 0000.

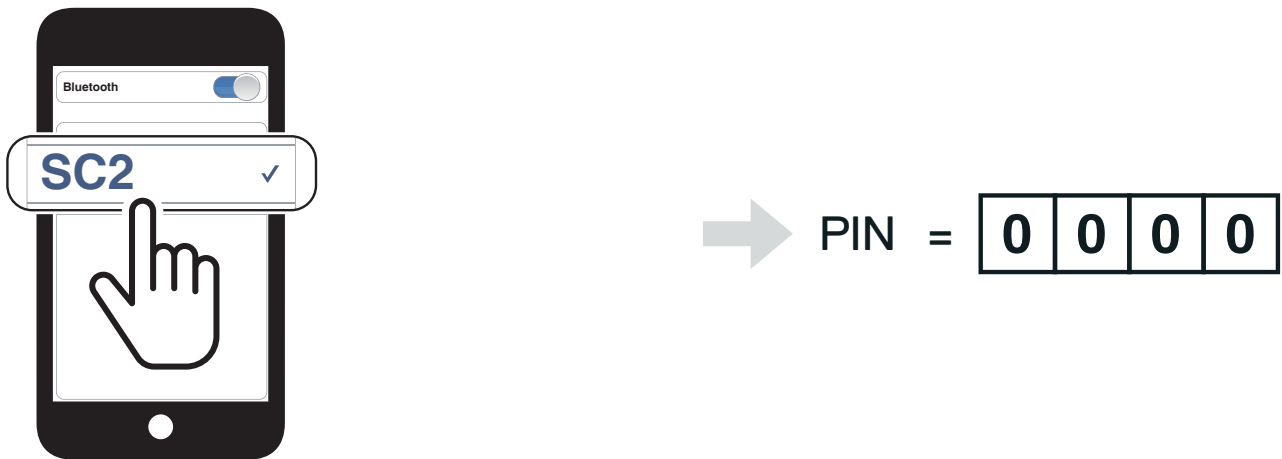

4.2 Second Mobile Phone Pairing - Second Mobile Phone, GPS, and SR10

1. Press and hold the **Center Button** for 10 seconds.



2. Double tap the **(+) Button**.

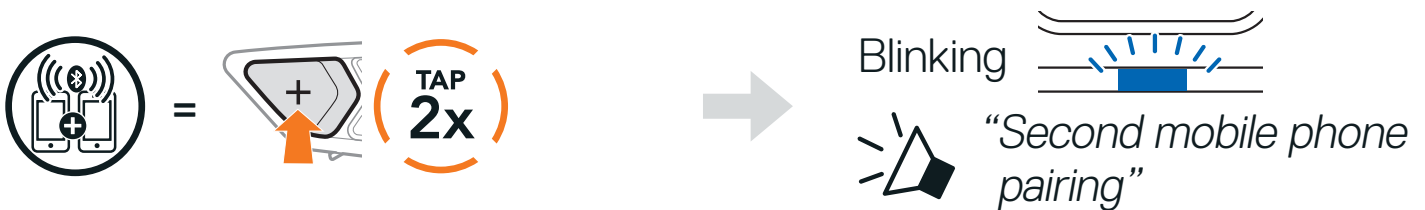

3. With your mobile phone in Bluetooth-pairing mode, select **SC2** in the list of devices detected.

If your device asks for a PIN, enter 0000.

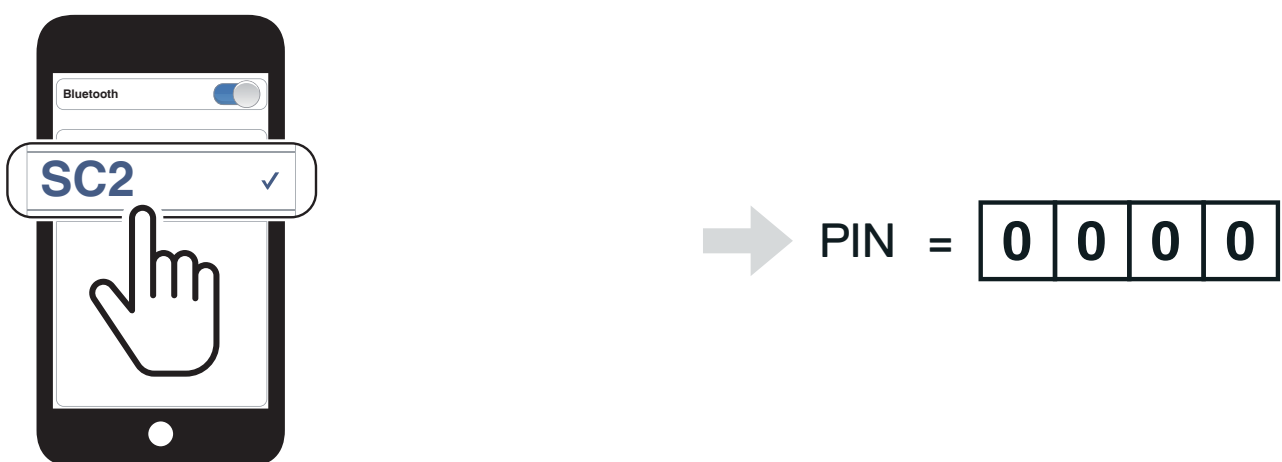

4.3 Advanced Selective Pairing: Hands-Free or A2DP Stereo

Phone Pairing allows the headset to establish two Bluetooth profiles: **Hands-Free** or **A2DP Stereo**. **Advanced Selective Pairing** allows the headset to separate the profiles to enable connection with two devices.

4.3.1 Phone Selective Pairing - Hands-Free Profile

1. Press and hold the **Center Button** for **10 seconds**.



2. Tap the **(+) Button** three times.

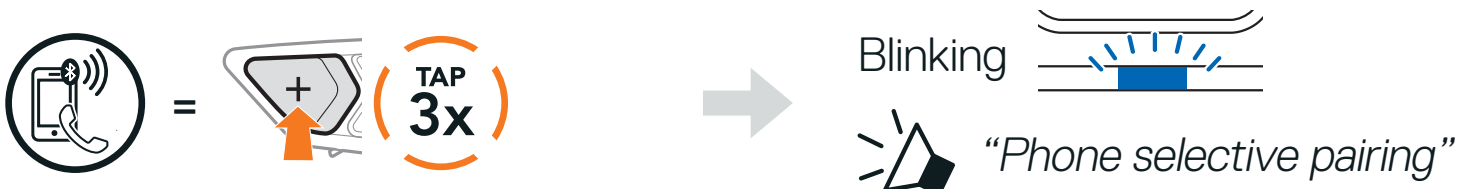

3. Select **SC2** in the list of Bluetooth devices detected.

If your mobile phone asks for a PIN, enter 0000.

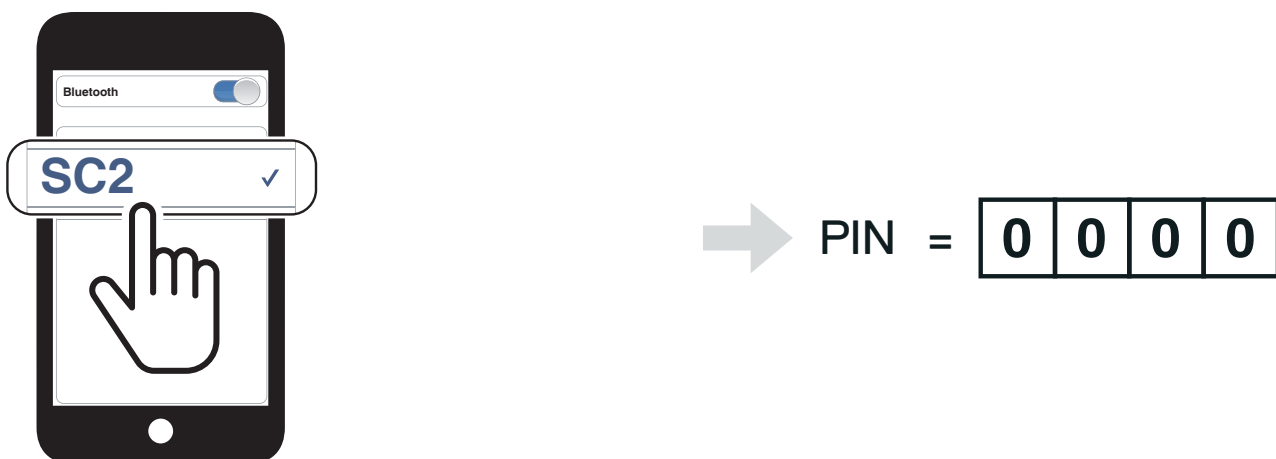

4.3.2 Media Selective Pairing - A2DP Profile

1. Press and hold the **Center Button** for **10 seconds**.



2. Tap the **(+) Button** four times.

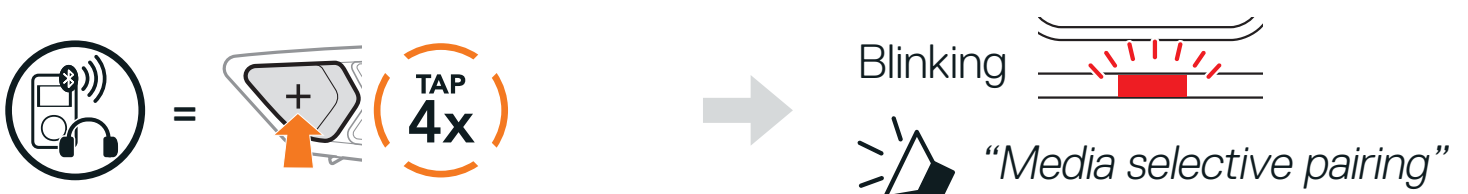

3. Select **SC2** in the list of Bluetooth devices detected.

If your mobile phone asks for a PIN, enter 0000.

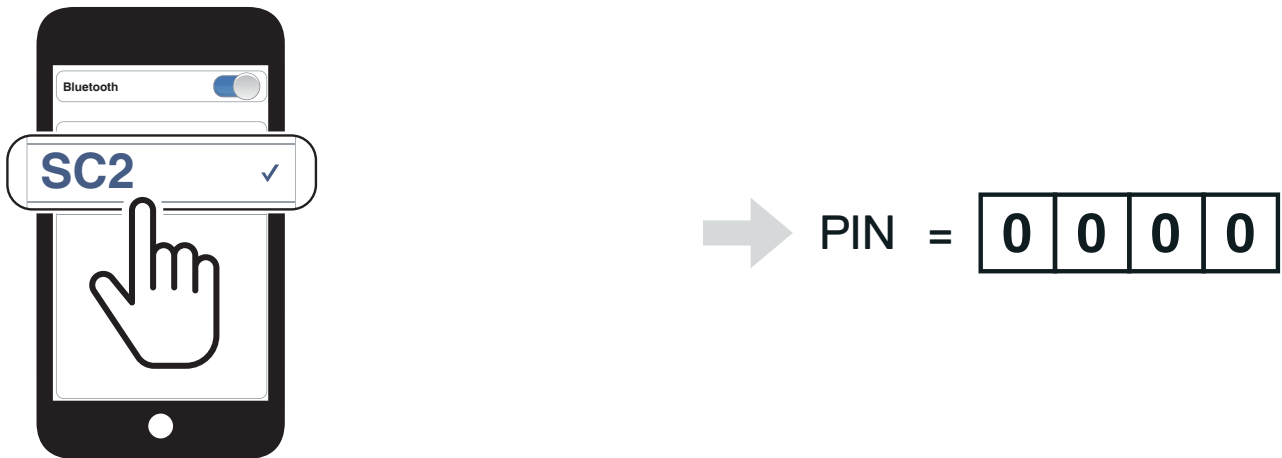

4.4 GPS Pairing

1. Press and hold the **Center Button** for **10 seconds**.



2. Tap the **(+) Button** five times.



3. Select **SC2** in the list of Bluetooth devices detected.

If your device asks for a PIN, enter 0000.

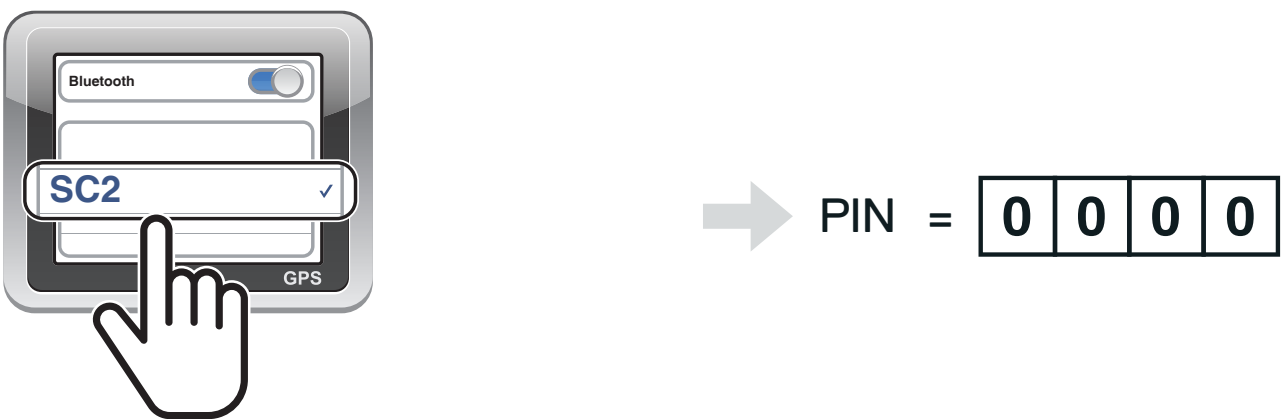

Note: If you pair your GPS device via GPS Pairing, its instruction will not interrupt your Mesh Intercom conversations, but overlay with them. Bluetooth intercom conversations will be interrupted by GPS instructions.

5. MOBILE PHONE USAGE

5.1 Making and Answering Calls

Answer a Call

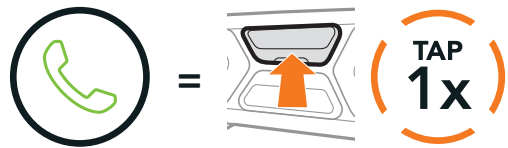

End a Call

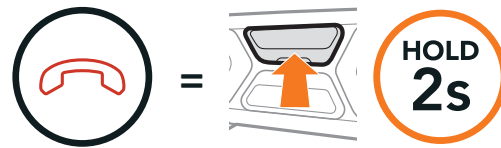

Reject a Call

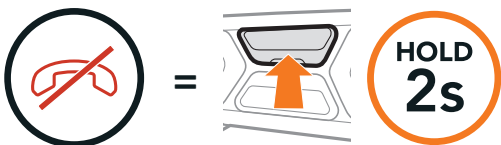

Note: If you have a GPS device connected, you will not hear its voice navigations during a phone call.

5.2 Siri and Google Assistant

The **headset** supports the **Siri** and **Google Assistant** access directly. You can activate the **Siri** or **Google Assistant** using the voice through the headset's microphone, a wake word will be used. This is a word or a group of words such as "Hey Siri" or "Hey Google".

Activate the Siri or Google Assistant installed on Your Smartphone

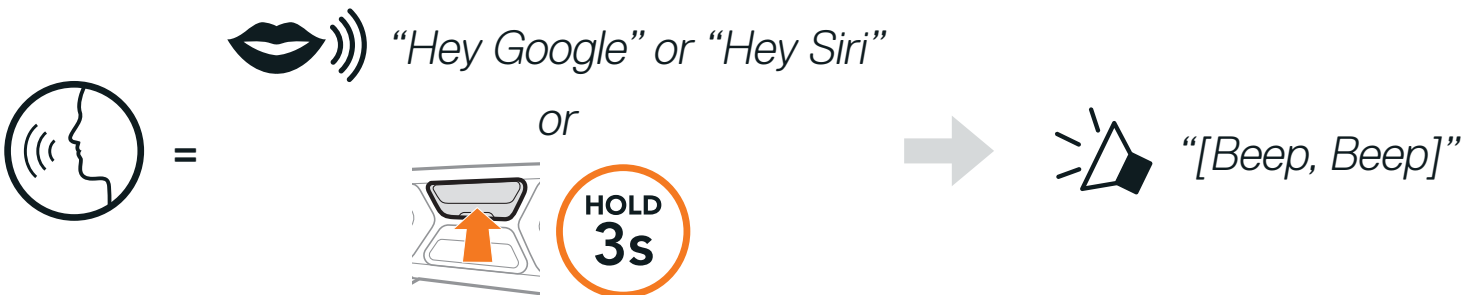

5.3 Speed Dialing

5.3.1 Assigning Speed Dial Presets

Speed Dial Presets could be assigned through the **SCHUBERTH SC2 App** or the **SCHUBERTH Device Manager**.

5.3.2 Using Speed Dial Presets

1. Press and hold the **(+) Button** for **3 seconds**.

Enter Speed Dial Mode



2. Tap the **(+) Button** or the **(-) Button** to navigate between the menus.

Navigate Forward or Backward through Speed Dial Preset Numbers

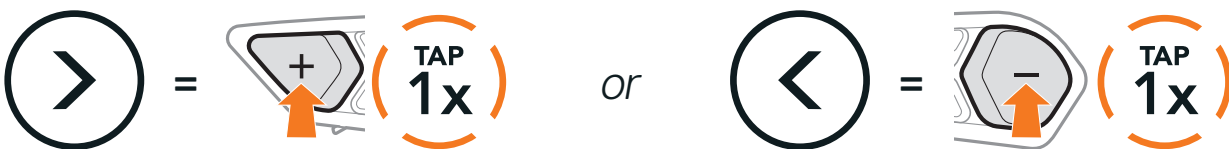

- (1) Last number redial
- (2) Speed dial 1
- (3) Speed dial 2

- (4) Speed dial 3
- (5) Cancel

3. To call one of your Speed Dial Presets, tap the **Center Button**.

Call a Speed Dial Preset Number



4. To redial the last phone call number, tap the **Center Button**.

Redial Last Number



6. STEREO MUSIC

6.1 Bluetooth Stereo Music

Play/Pause Music



Next Track

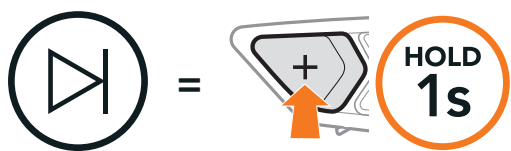

Previous Track

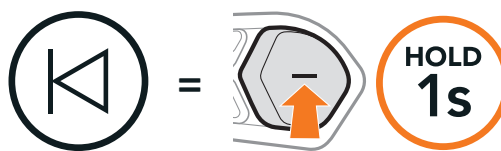

6.2 Music Sharing

You can start sharing music with one intercom friend using Bluetooth stereo music during a two-way intercom conversation and one participant of a Mesh. If you start sharing music while Bluetooth intercom and Mesh Intercom are running at the same time, then music shared during Bluetooth intercom will take priority over music shared during Mesh Intercom.

Note:

- ◆ Both you and your intercom friend can remotely control music playback such as track forward and track back.
- ◆ **Music sharing** will be paused when you are using your mobile phone or listening to GPS instructions.
- ◆ **Music sharing** will be terminated if the headset starts a multi-way intercom conference.

6.2.1 Bluetooth Intercom Music Sharing

You can start sharing music with one intercom friend of a two-way intercom conversation.

Press and hold the (-) Button for 3 seconds.

Start/Terminate Sharing Music



6.2.2 Mesh Intercom Music Sharing

You (**Creator**) can start sharing music with one participant of a **Mesh Intercom**.

1. To send a request message to **participants** connected during **Mesh Intercom**, press and hold the (-) Button for 3 seconds.

[You (Creator)]

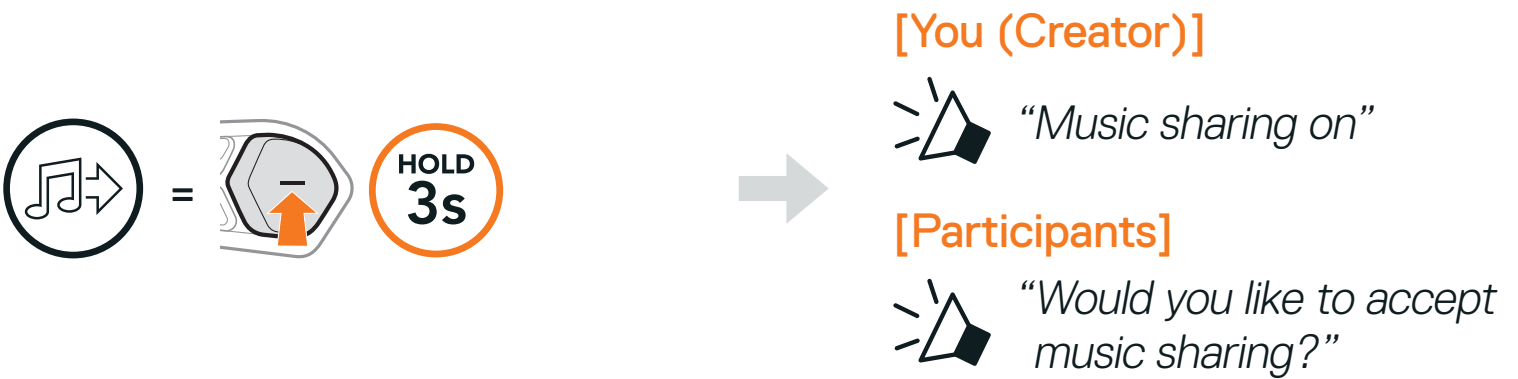

2. You (**Creator**) can share music with the **first participant** that accepts the request by tapping the **Mesh Intercom Button**.

[Participant] Accept

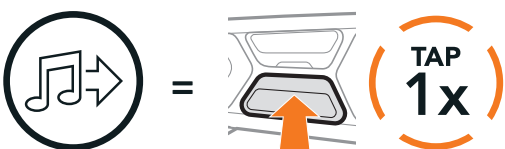

[Participant] Refuse

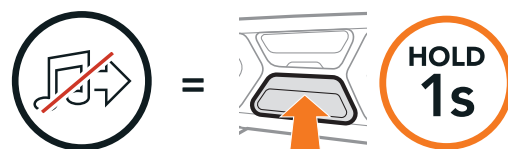

7. MESH INTERCOM

7.1 What is Mesh Intercom?

Mesh Intercom™ is a dynamic communication system that provides instant and effortless bike-to-bike communication without a pre-grouping process. **Mesh Intercom** allows riders to connect and communicate with nearby users without the need to pair each headset together.

Within the same channel in **Open Mesh™** or the same private group in **Group Mesh™**, six users can talk at the same time and enjoy the optimal quality for their conversation.

Mesh Intercom

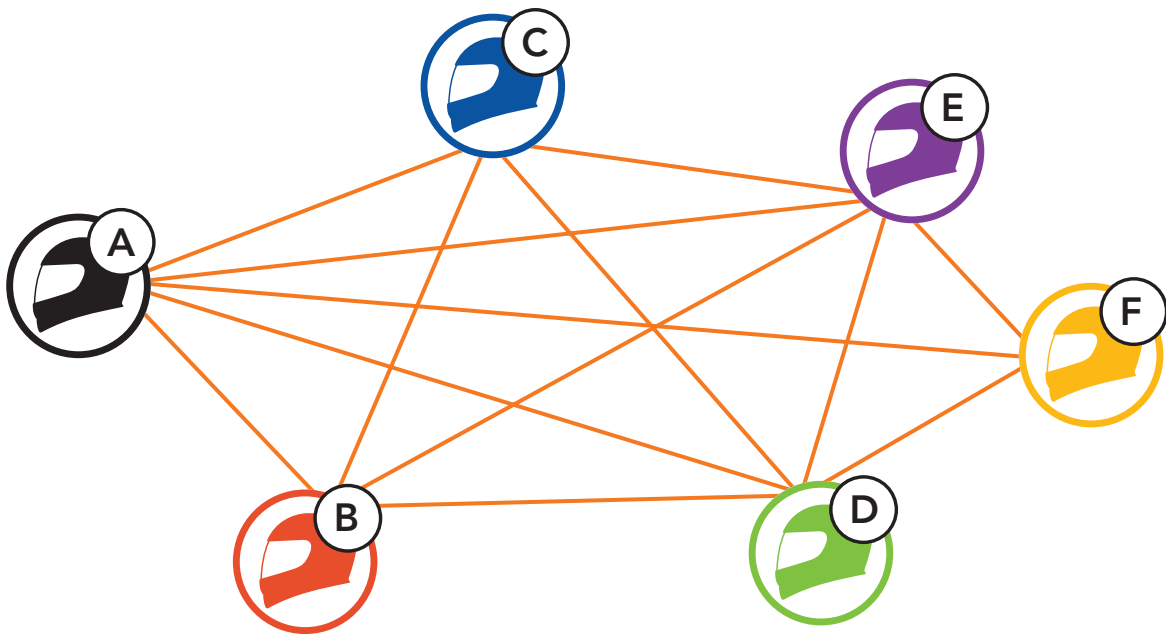

7.1.1 Open Mesh

Open Mesh is an open group intercom function. Users can freely communicate with each other in the same **Open Mesh** channel and select which channel (1-9) to use through the headset.

It can connect with a virtually unlimited number of users in each channel.

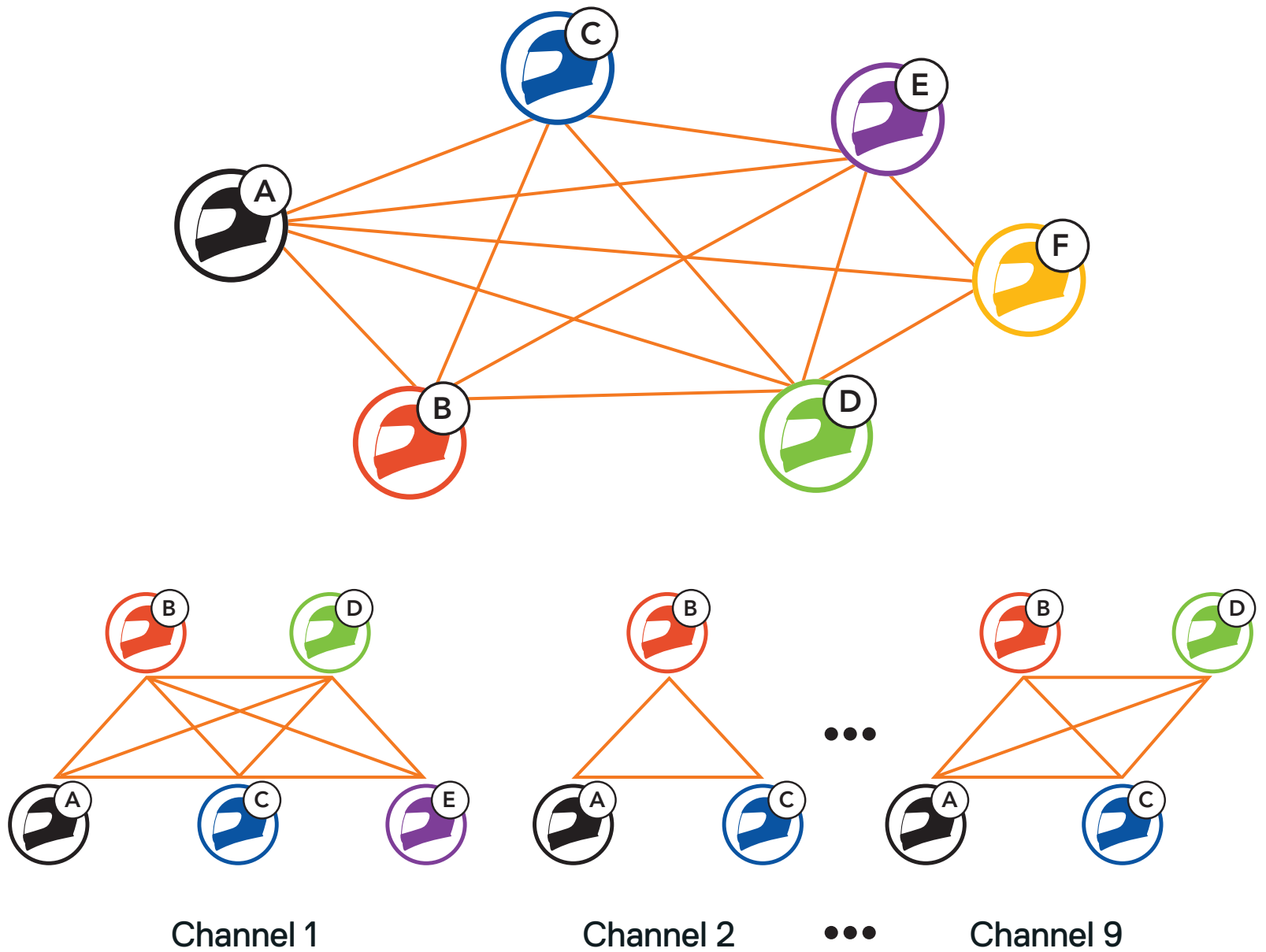

7.1.2 Group Mesh

Group Mesh is a closed group intercom function that allows users to join, leave, or rejoin a group intercom conversation without pairing each headset. Users can freely communicate with each other in the same private group in **Group Mesh**.

For closed intercom conversations using **Mesh Intercom**, a **Group Mesh** needs to be created by the users. When users create a private group in **Group Mesh** by **Mesh Grouping**, the headset automatically switches from **Open Mesh** to **Group Mesh**. Up to 24 users can all be connected in each private group.

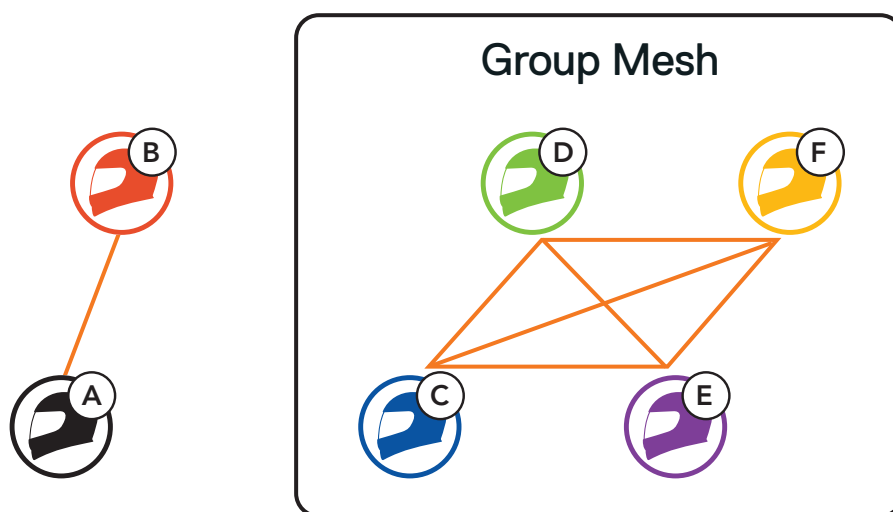

7.2 Starting Mesh Intercom

When **Mesh Intercom** is enabled, the **SC2** will automatically connect to nearby all other Mesh users and allow them to talk to each other by tapping the **Mesh Intercom Button**.

Mesh Intercom On

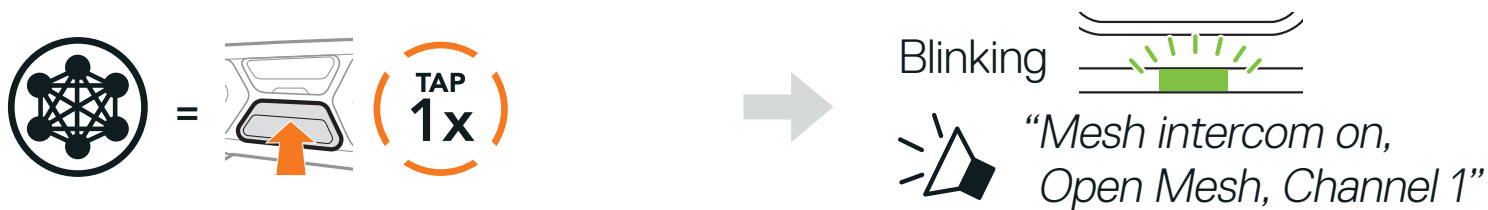

Mesh Intercom Off



7.3 Using the Mesh in Open Mesh

When **Mesh Intercom** is enabled, the headset will be in **Open Mesh (default: channel 1)** initially.

7.3.1 Channel Setting (Default: Channel 1)

If the **Open Mesh** communication experiences interference because other groups are also using **channel 1 (default)**, change the channel. You can select from channels 1 to 9.

1. Double tap the **Mesh Intercom Button**.



2. Tap the **(+) Button** or the **(-) Button** to navigate between channels.
(1 → 2 → ... → 8 → 9 → Exit → 1 → ...)



3. Tap the **Center Button** to save the channel.



Note:

- ◆ **Channel Setting** always starts with **channel 1**.
- ◆ If you do not press any button for approximately **10 seconds** in a specific channel, the channel is automatically saved.
- ◆ The channel will be remembered even if you turn off the **headset**.
- ◆ You can use the **SCHUBERTH SC2 App** to change the channel.

7.4 Using Mesh in Group Mesh

7.4.1 Creating a Group Mesh

Creating a **Group Mesh** requires **two or more Open Mesh users**.

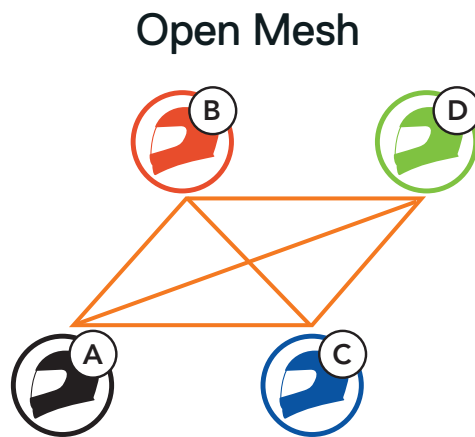

1. To enter **Mesh Grouping** to create a **Group Mesh**, press and hold the **Mesh Intercom Button** for **5 seconds** on the headset of **You (C)** and **your friend (D)**.

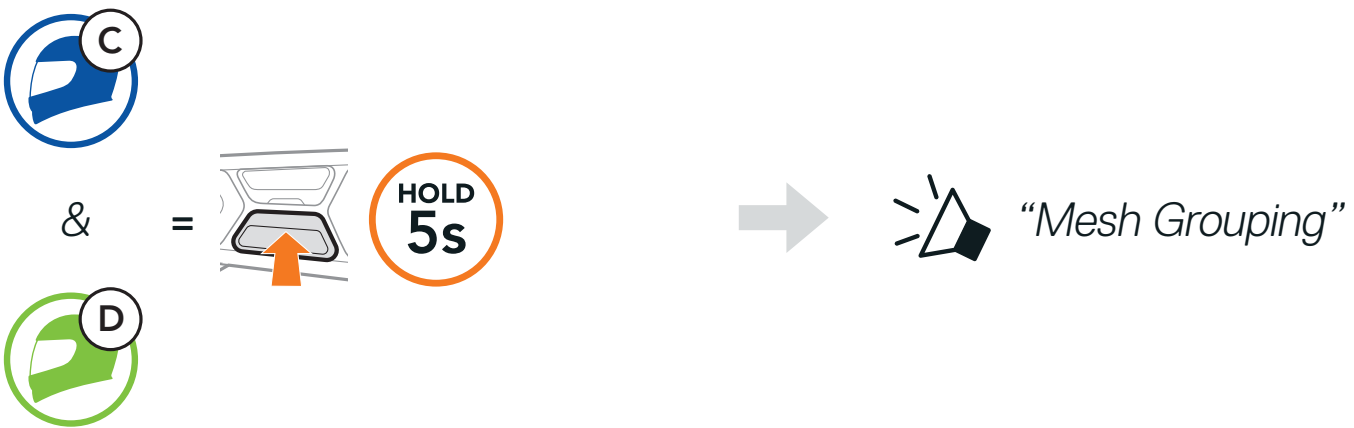

2. The headsets complete **Mesh Grouping** and automatically switch from **Open Mesh** to **Group Mesh**.



Open Mesh

Group Mesh

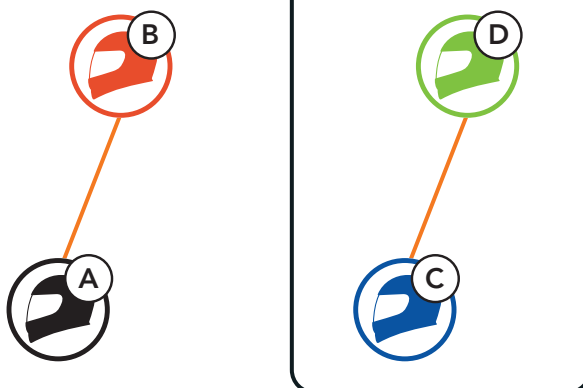

Note:

- ◆ If the **Mesh Grouping** is not completed within **30 seconds**, users will hear a voice prompt, "**Grouping failed**".
- ◆ If you want to cancel during the **Mesh Grouping**, tap the **Mesh Intercom Button**.

7.4.2 Joining an Existing Group Mesh

One of the members in an **Existing Group Mesh** can allow new members in **Open Mesh** to join the **Existing Group Mesh**.

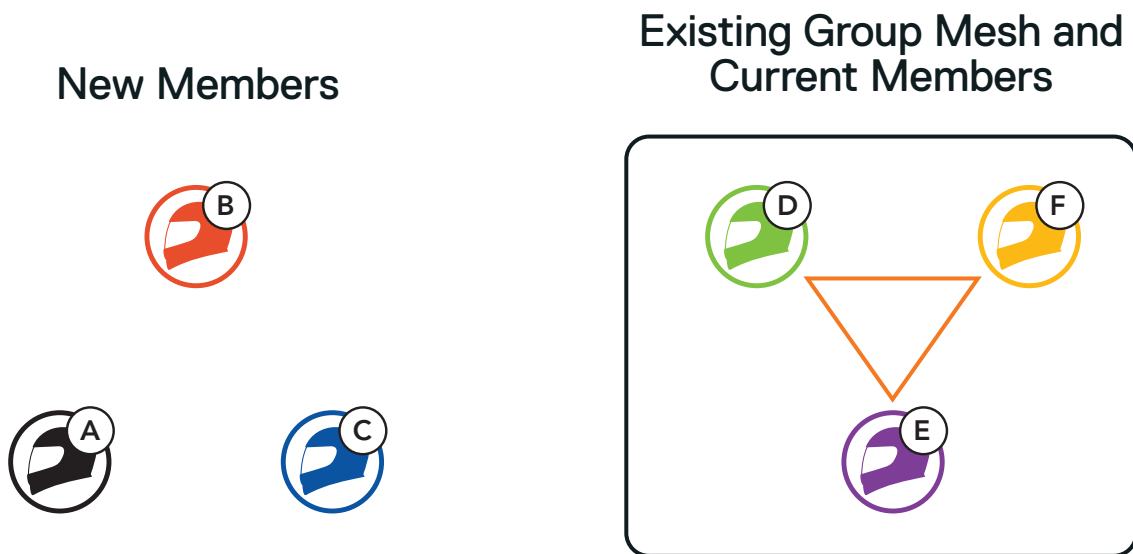

1. To enter **Mesh Grouping** to join the **Existing Group Mesh**, press and hold the **Mesh Intercom Button** for **5 seconds** on the headset of **One of the current members (E)** and a **new member (you [C])**.

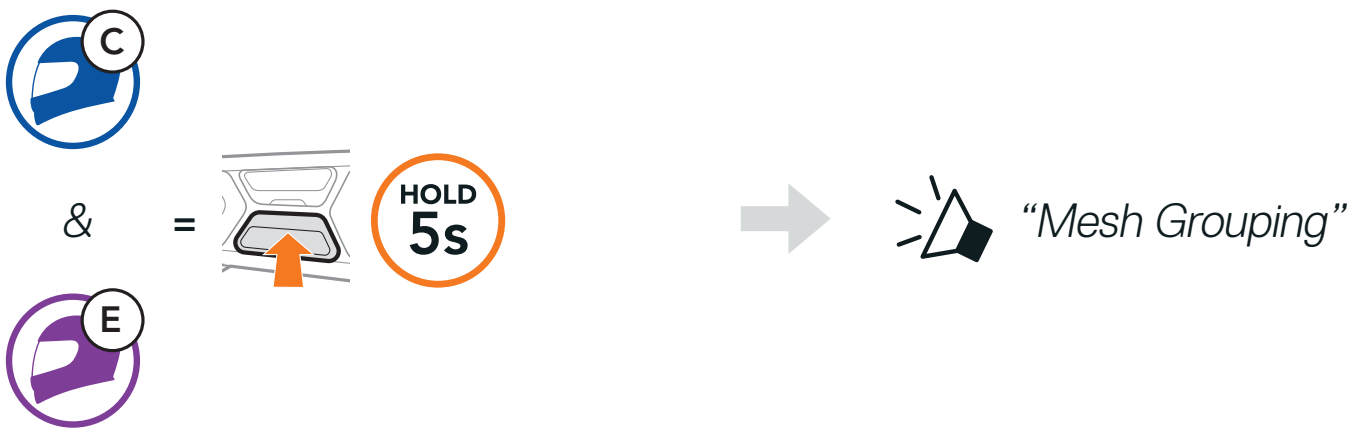

2. The headsets complete **Mesh Grouping**. The new members will hear a voice prompt as their headsets automatically switch from **Open Mesh** to **Group Mesh**.

 "Group Mesh"

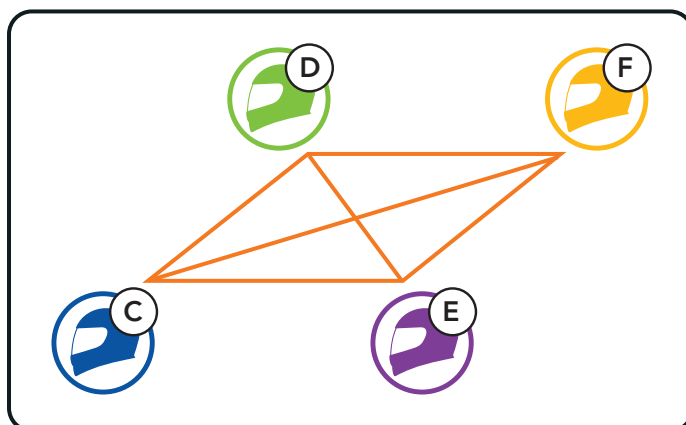

Note: If the **Mesh Grouping** is not completed within **30 seconds**, the current members will hear a low tone double beep and the new member will hear a voice prompt, "**Grouping failed**".

7.5 Enable/Disable Mic (Default: Enable)

Users can enable/disable the microphone when communicating in a **Mesh Intercom**.



7.6 Toggling Open Mesh/Group Mesh

Users are able to toggle between **Open Mesh** and **Group Mesh** without resetting the **Mesh**. This allows users to keep the **Group Mesh Network** connection information while in **Open Mesh**.

Users can toggle to **Group Mesh** to communicate with participants from the stored **Group Mesh Network** connection information.

Toggle Between Open Mesh and Group Mesh

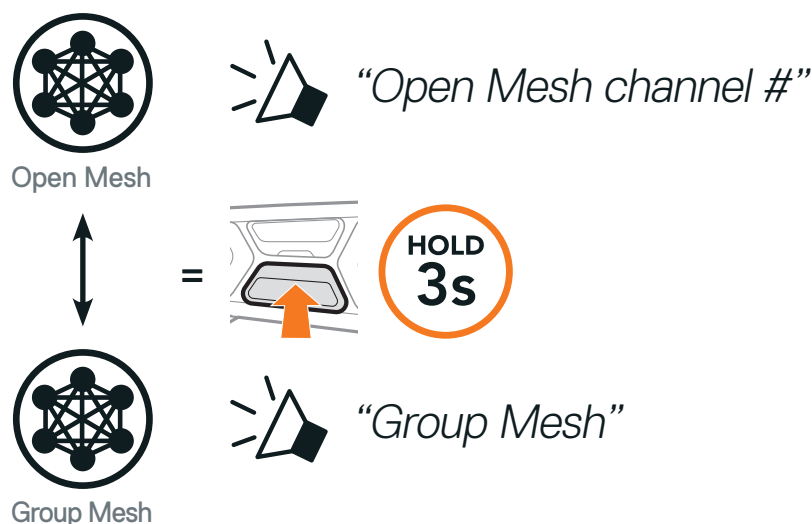

Note: If you have never participated in **Group Mesh**, you cannot toggle between **Open Mesh** and **Group Mesh**. You will hear a voice prompt, "No Group Available".

7.7 Reset Mesh

If a headset in an **Open Mesh** or **Group Mesh** resets the **Mesh**, it will automatically return to **Open Mesh** (default: channel 1).



8. BLUETOOTH INTERCOM

Up to three people can communicate via intercom with the headset simply by pairing their headsets.

Pairing with Intercom Friends

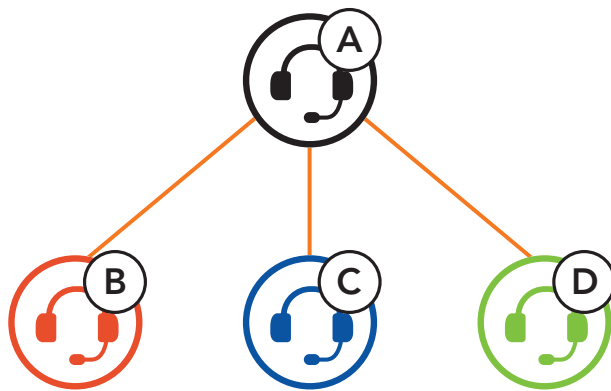



8.1 Intercom Pairing

There are two ways to pair the headset.

8.1.1 Using the Smart Intercom Pairing (SIP)

SIP allows you to quickly pair with your friends for intercom communication by scanning the QR code on the **SCHUBERTH SC2 App** without remembering the button operation.

1. Pair the mobile phone with the headset.
2. Open the **SCHUBERTH SC2 App** and tap  (**Smart Intercom Pairing Menu**).
3. Scan the **QR code** displayed on your friend (**B**)'s mobile phone.
 - ◆ Your friend (**B**) can display the QR code on the mobile phone by tapping  > **QR code** () on the **SCHUBERTH SC2 App**.

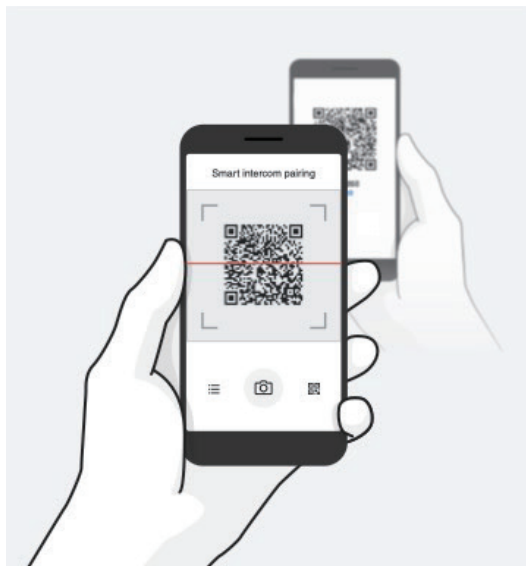

4. Tap **Save** and check that your friend **(B)** is paired with **you (A)** correctly.
5. Tap **Scan** (📷) and repeat steps 3-4 to pair with **Intercom Friends (C)** and **(D)**.

Note: The **Smart Intercom Pairing (SIP)** is not compatible with Sena products that use **Bluetooth 3.0** or **below**.

8.1.2 Using the Button

1. Press and hold the **Center Button** of two headsets for **5 seconds** until you hear a voice prompt, **“Intercom pairing”**.

Pairing Headset A with Headset B



2. The **SC2** will automatically pair with a SCHUBERTH headset.

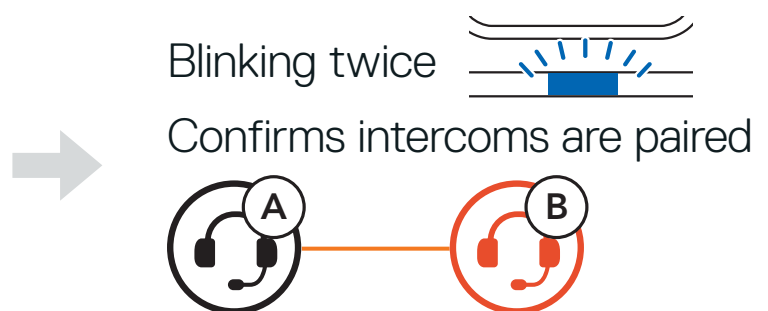

3. Repeat the steps above to pair with **Intercom Friends C & D**.

8.2 Last-Come, First-Served

The intercom pairing queue is **Last-Come, First-Served**. If a headset has multiple paired headsets for intercom conversations, the last paired headset is set as the **First Intercom Friend**. For example, after the pairing procedures listed above, **headset (D)** is the **First Intercom Friend** of headset **(A)**. **Headset (C)** is the **Second Intercom Friend** of headset **(A)**, and **headset (B)** is the **Third Intercom Friend** of headset **(A)**.

Last-Come, First-Served

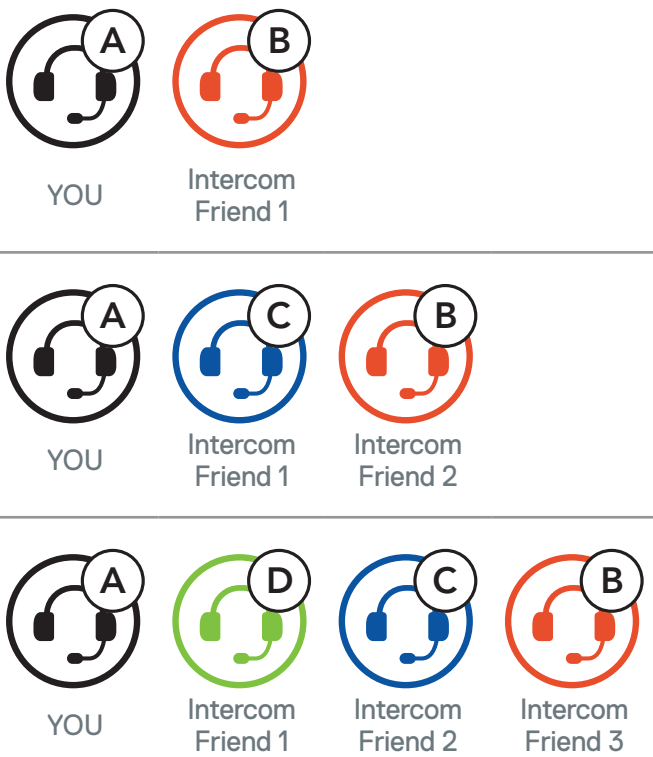

8.3 Two-Way Intercom

You can start or end an intercom conversation with an Intercom Friend by tapping the **Center Button**.

1. Tap once for Intercom **Friend 1**.

Start/End with Intercom Friend 1

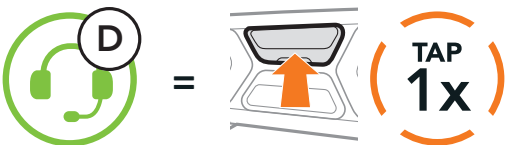

2. Tap twice for Intercom **Friend 2**.

Start/End with Intercom Friend 2

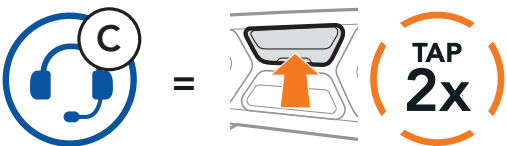

3. Tap three times for Intercom **Friend 3**.

Start/End with Intercom Friend 3

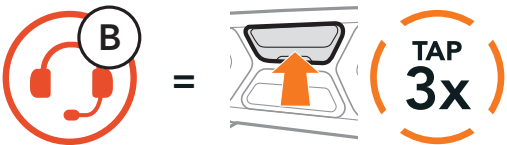

8.4 Multi-Way Intercom

Multi-Way Intercom enables conference-call-style conversations with up to three **Intercom Friends** at the same time. While **Multi-Way Intercom** is in progress, mobile phone connection is temporarily disconnected. However, as soon as **Multi-Way Intercom** terminates, the mobile phone connection will be reestablished.

8.4.1 Starting a Three-Way Intercom Conference

You (A) can have a **Three-Way Intercom Conference** with two other **Intercom Friends** (B & C) by establishing two intercom connections simultaneously.

1. Pair your headset (A) with those of two other **Intercom Friends** (B & C).

Pair with Intercom Friends B & C, refer to Section 8.1: “Intercom Pairing”

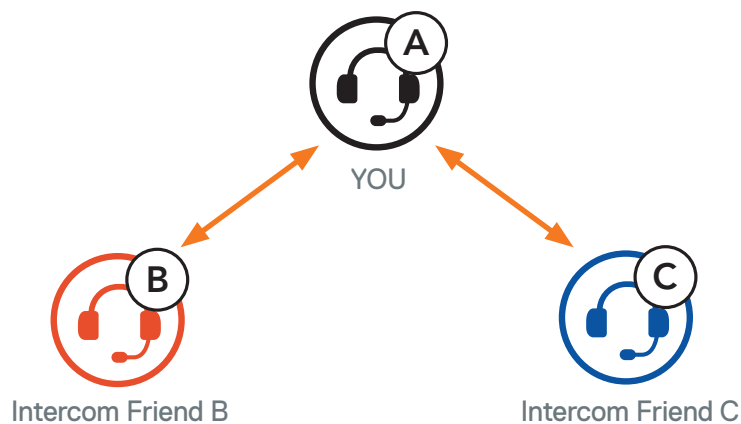

2. Start an intercom conversation with one of the two friends in your intercom group. For example, **you (A)** may start an intercom conversation with the **Intercom Friend (B)**. Or, **Intercom Friend (B)** may start an intercom call with **you (A)**.

Starting an Intercom Conversation with Intercom Friend B

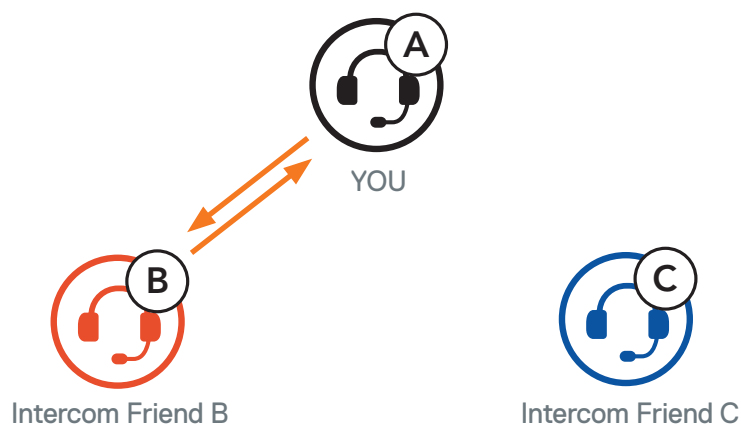

- Then, **you (A)** can call the **Second Intercom Friend (C)**, or the **Second Intercom Friend (C)** may join the intercom by making an intercom call to **you (A)**.

Starting an Intercom Conversation with Intercom Friend C

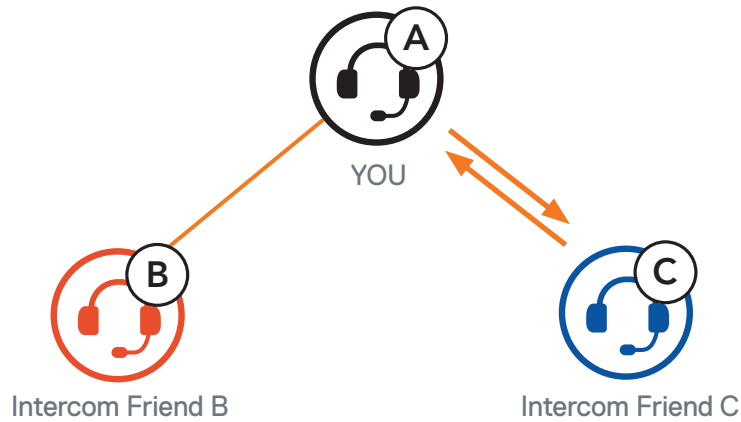

- Now **you (A)** and two **Intercom Friends (B & C)** are having a **Three-Way Intercom Conference**.

Three-Way Intercom

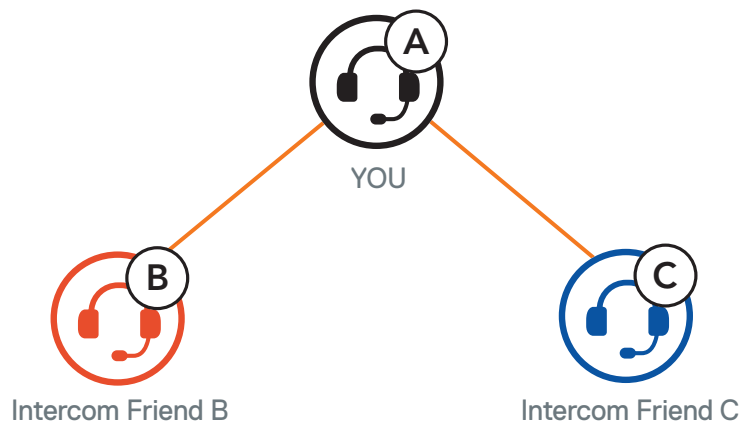

8.4.2 Starting a Four-Way Intercom Conference

With three **Intercom Friends** connected, a new participant (**D**) can make it a **Four-Way Intercom Conference** by making an intercom call to either (**B**) or (**C**).

Starting a Four-Way Intercom

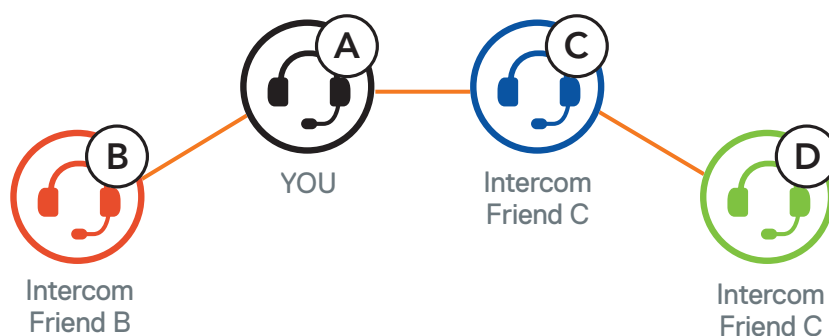

8.4.3 Ending Multi-Way Intercom

- Press and hold the **Center Button** for **3 seconds** until you hear a beep to terminate all intercom connections.
- Tap the **Center Button** to disconnect from your **First Intercom Friend**. Double tap the **Center Button** to disconnect from your **Second Intercom Friend**.

8.5 Three-Way Conference Phone Call with Intercom Users

You can have a **Three-Way Conference Phone Call** by adding an **Intercom Friend** to the mobile phone conversation.

1. During a mobile phone call, tap the **Center Button** **once, twice, or three times** to invite one of your **Intercom Friends** to the conversation.

Invite an Intercom Friend into Phone Conference

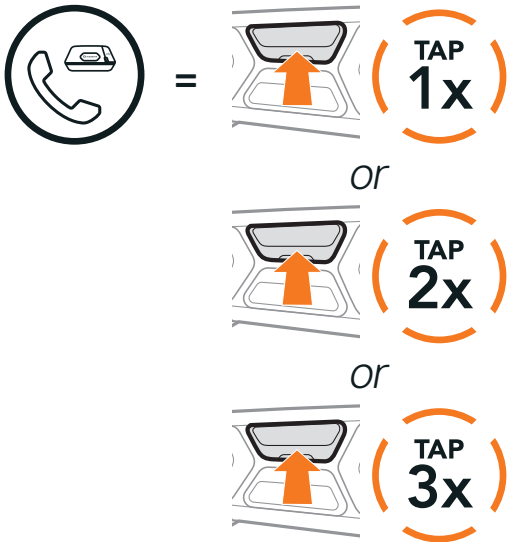

2. To disconnect the intercom during a conference phone call, tap the **Center Button** **once, twice, or three times**.

Disconnect Intercom Friend from Conference

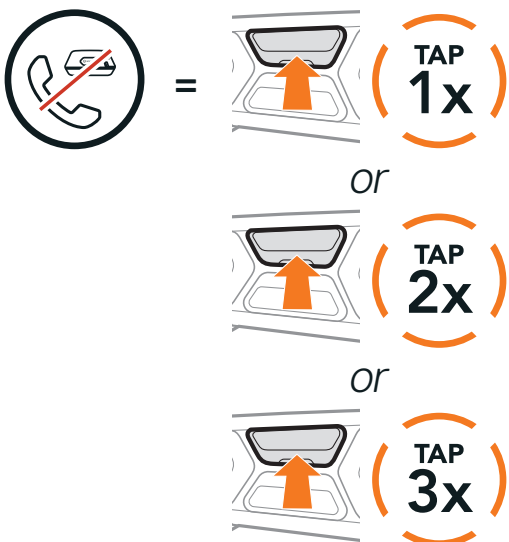

3. To disconnect the mobile phone call during a conference phone call, press and hold the **Center Button** for **2 seconds**.

End Phone Call from Conference

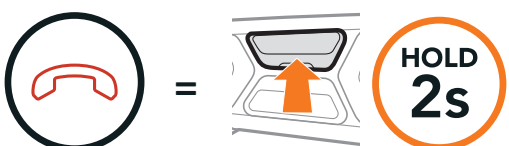

Note: When you have an incoming intercom call during a mobile phone call, you will hear high tone double beeps.

8.6 Group Intercom

Group Intercom allows you to instantly create a **Multi-Way Conference Intercom** with three of the most recently paired headsets.

Start the Group Intercom

1. Go through intercom pairing with up to three headsets you want to have **Group Intercom** with.
2. Tap the **(+) Button** and **(-) Button** to begin **Group Intercom**.

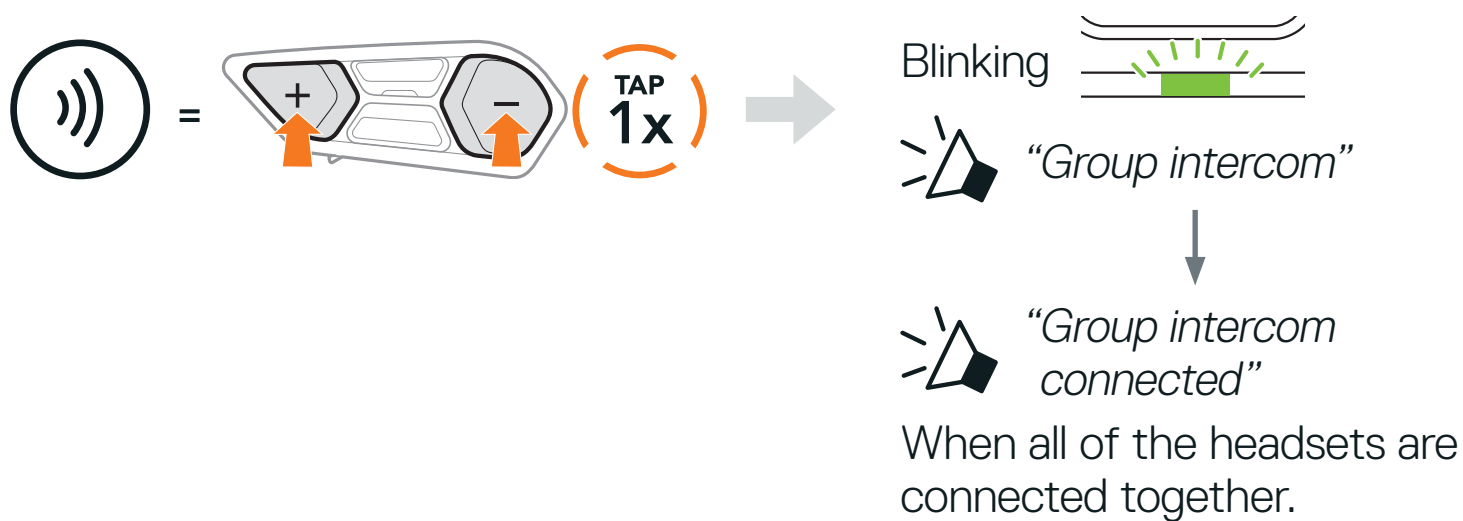

Terminate Group Intercom

To terminate **Group Intercom**, press and hold the **Center Button** for **3 seconds** during **Group Intercom**.



8.7 Mesh Intercom Conference with Bluetooth Intercom Participant

Users can use the existing Bluetooth intercom and **Mesh Intercom** function at the same time. In this case, it is recommended to communicate with other SCHUBERTH headsets via Bluetooth intercom connection and use **Mesh Intercom** between **SC2** headsets. A user who is in **Open Mesh** or **Group Mesh** when using **Mesh Intercom** is able to include up to 3 of their Bluetooth intercom friends. You can start a **Two-Way Intercom conversation** with one of your three Intercom Friends to include them in the **Mesh**.

Note:

- ◆ The audio quality will be reduced if a **SC2** connects to 2 or more Bluetooth intercom friends while in **Open Mesh** or **Group Mesh** when using **Mesh Intercom**.
- ◆ If a closed loop is created, as shown below, each user will experience severe noise issues. SCHUBERTH recommends that a closed loop not be created.

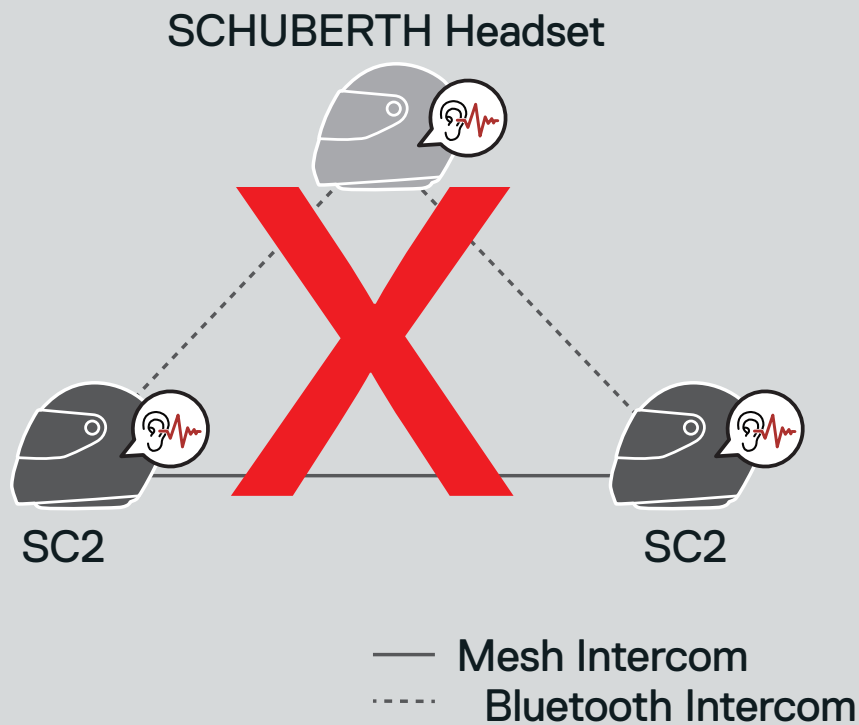

- ◆ If **Bluetooth intercom** is accidentally turned on during **Mesh Intercom** communication between **SC2** headsets, as shown below, you will hear a voice prompt, “**Mesh intercom disabled, Bluetooth intercom connected**” every **1 minute**. If you turn off the **Bluetooth Intercom** or turn off the **Mesh Intercom**, the voice prompt will no longer come out.

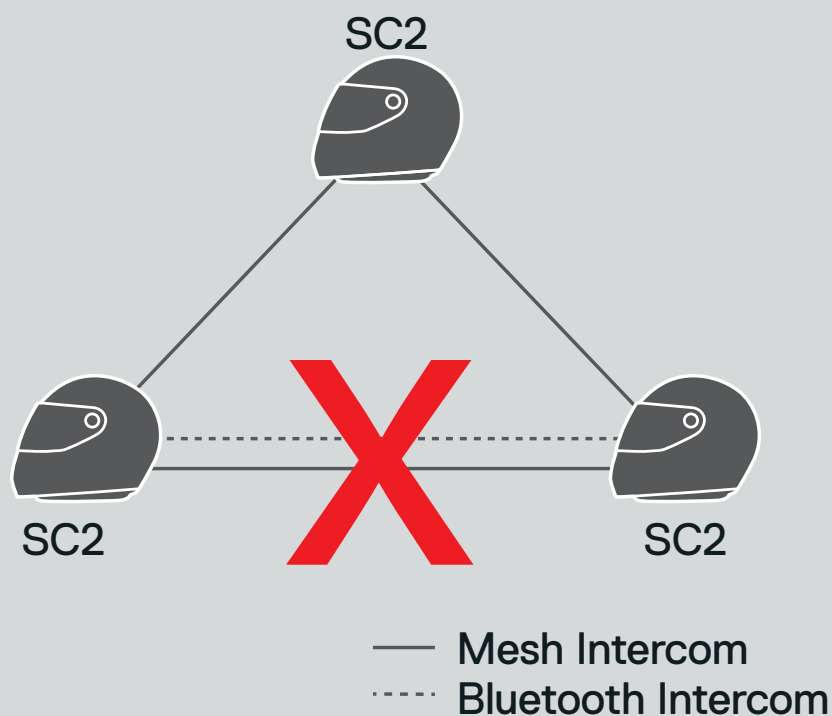

8.8 Universal Intercom

Universal Intercom allows you to have intercom conversations with users of non-SCHUBERTH Bluetooth headsets. Non-SCHUBERTH Bluetooth headset can be connected to the SCHUBERTH headset if they support the **Bluetooth Hands-Free Profile (HFP)**. You can pair your headset with only one non-SCHUBERTH headset at a time. The intercom distance depends on the performance of the Bluetooth headset to which it is connected. When a non-SCHUBERTH Bluetooth headset is paired with the SCHUBERTH headset, if another Bluetooth device is paired via **Second Mobile Phone Pairing**, it will be disconnected.

1. Press and hold the **Center Button** for **10 seconds**.



2. Tap the **(-) Button** three times.



3. Tap the **Center Button**.

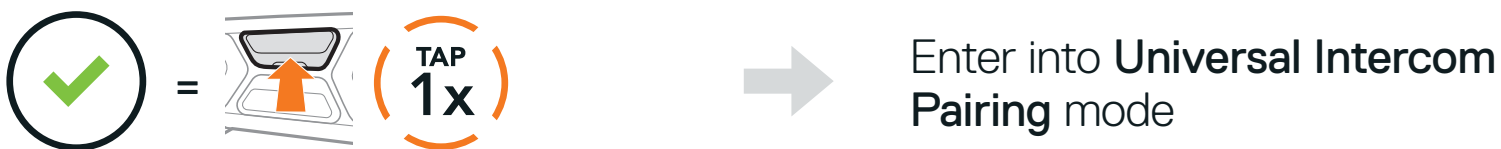

4. Put the non-SCHUBERTH Bluetooth headset in Pairing Mode. The headset will automatically pair with a non-SCHUBERTH Bluetooth headset.
5. You can have **Two-Way Intercom** or **Multi-Way Intercom communication** with up to three **Intercom Friends** using non-SCHUBERTH headsets by following the procedures described below.

Example of a Three-Way Universal Intercom

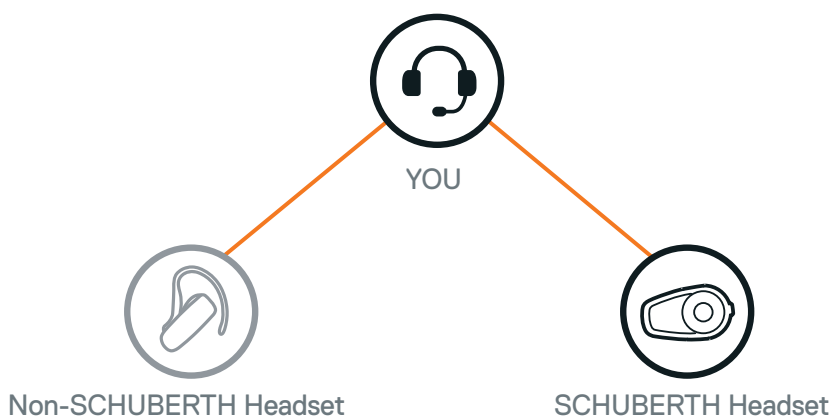

Example of a Four-Way Universal Intercom

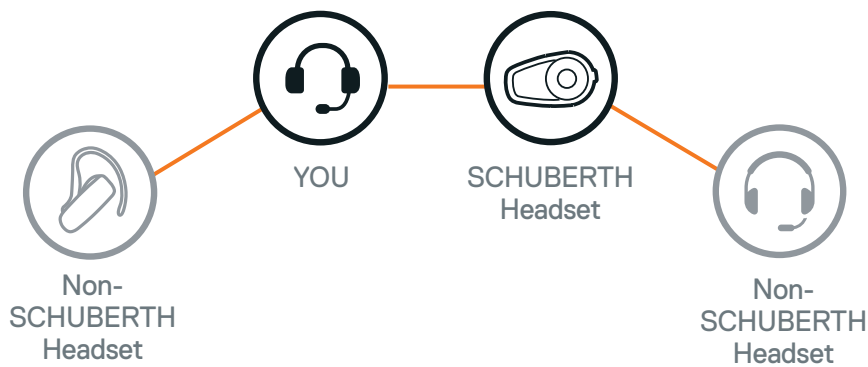

Note: Some non-SCHUBERTH headsets may not support Multi-Way Universal Intercom.

8.9 Mesh Intercom Conference with Two-way Universal Intercom Participant

Users can use the existing **Two-way Universal Intercom** and **Mesh Intercom** function at the same time. In this case, it is recommended to communicate with **non-SCHUBERTH headset** via **Two-way Universal Intercom** connection and use **Mesh Intercom** between **SC2** headsets.

A user who is in **Open Mesh** or **Group Mesh** when using **Mesh Intercom** is able to include one **Universal Intercom Friend**. You can start a **Two-way Universal Intercom** conversation with your **Universal Intercom Friend** to include it in the **Mesh**.

9. USING THE FM RADIO

9.1 FM Radio On/Off

FM Radio On



FM Radio Off



9.2 Seek and Save Radio Stations

The “**Seek**” feature searches for radio stations.

1. Search for radio stations.

Seek Stations Forward

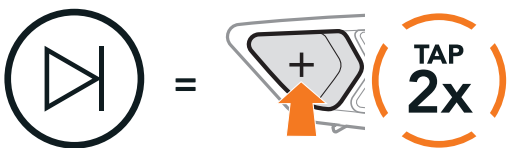

Seek Stations Backward

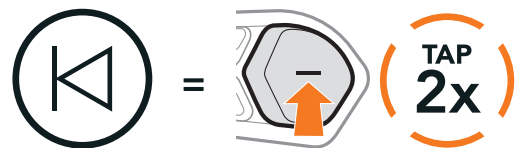

2. Save the current station.

Enter Preset Selection Mode



3. Navigate through the preset numbers that you want to store.

Navigate Forward/Backward Through Preset Stations

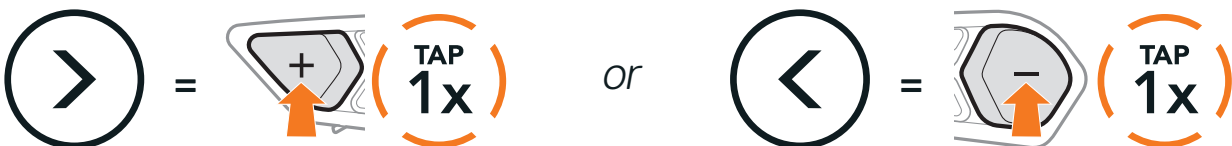

- Save the station in the preset number you choose or delete the station from memory.

Save Station to the Preset Number



Delete Station from Memory



9.3 Scan and Save Radio Stations

The “**Scan**” function automatically searches for radio stations, starting with the current station’s frequency, then up from there.

- Scan for stations.

Start Scanning



- The SCHUBERTH tuner pauses at each station it finds for **8 seconds** before moving to the next.
- Save the current station. The station will be saved as the next preset number.

Save the Current Station



- Stop scanning.

Stop scanning

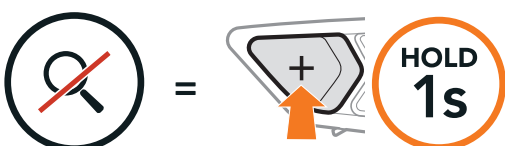

Note: You can use the **SCHUBERTH Device Manager** or the **SCHUBERTH SC2 App** to save the preset stations.

9.4 Navigating Preset Stations

Using the methods above, up to 10 radio stations can be stored. You can navigate through the saved stations.

Navigate through Preset Stations

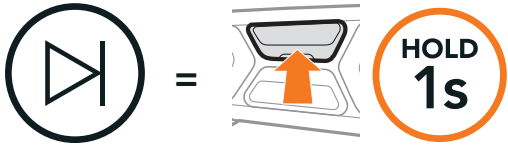

9.5 Temporary Station Preset

The **Temporary Preset** feature automatically finds and saves the nearest 10 radio stations without changing your existing preset stations.

1. Automatically find and save 10 stations.

Temporary Stations

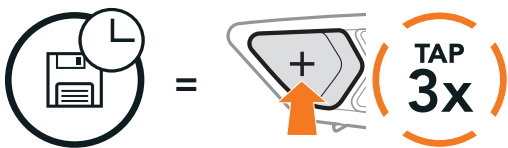

2. The temporary preset stations will be cleared when the headset reboots.

9.6 Region Selection

You can select the proper FM frequency range for your location from the **SCHUBERTH Device Manager** or the **SCHUBERTH SC2 App**. Using the region setting, you can optimize the seek function to avoid unnecessary frequency ranges.

Region	Frequency range	Step
Worldwide	76.0 ~ 108.0 MHz	± 100 kHz
North America, South America and Australia	87.5 ~ 107.9 MHz	± 200 kHz
Asia and Europe	87.5 ~ 108.0 MHz	± 100 kHz
Japan	76.0 ~ 95.0 MHz	± 100 kHz

10. VOICE COMMAND

The **Voice Command** of the headset allows you to operate certain operations by simply using your voice. You can control the headset completely hands-free using the voice recognition. Multi-language Voice Command supports **English, French, German, Spanish, Italian, Chinese, Japanese, and Russian.**

Speak a Voice Command List

Mode Status	Function	Voice Command
Standby/ Bluetooth Intercom/ Mesh Intercom/ FM Radio/ Music	Check battery	"Hey Sena, Check Battery"
	Volume Up	"Hey Sena, Volume Up"
	Volume Down	"Hey Sena, Volume Down"
	Phone Pairing	"Hey Sena, Phone Pairing"
	Bluetooth Intercom Pairing	"Hey Sena, Pairing Intercom"
	Start/End each Bluetooth Intercom	"Hey Sena, Intercom [one, two, three]"
Standby/ Bluetooth Intercom/ FM Radio/ Music	Turn on Mesh Intercom	"Hey Sena, Mesh On"
Mesh Intercom	Turn off Mesh Intercom	"Hey Sena, Mesh Off"
	Mesh Grouping	"Hey Sena, Mesh Grouping"
	Switch to Open Mesh	"Hey Sena, Open Mesh"
	Switch to Group Mesh	"Hey Sena, Group Mesh"
	End the Bluetooth intercom and Mesh intercom	"Hey Sena, End intercom"
Standby/ Bluetooth Intercom/ Mesh Intercom	Play Music	"Hey Sena, Play Music"

Mode Status	Function	Voice Command
Standby/ Intercom/ Mesh Intercom/ Music	Turn on FM radio	"Hey Sena, FM Radio On"
Music/ FM Radio	<ul style="list-style-type: none"> ◆ FM - Next Preset ◆ Music - Next Track 	"Hey Sena, Next"
	<ul style="list-style-type: none"> ◆ FM - Previous Preset ◆ Music - Previous Track 	"Hey Sena, Previous"
Music	Pause Music	"Hey Sena, Stop Music"
FM Radio	Turn off FM Radio	"Hey Sena, FM Radio Off"
Answer an Incoming Call		"Answer"
Ignore an Incoming Call		"Ignore"

Note:

- ◆ You can set a language to another language by using the **Headset Language** feature on the **SCHUBERTH SC2 App**.
- ◆ If you set a language that does not support voice commands, the voice command will work only with **English commands**.
- ◆ You can see the another language's voice command list on the **SCHUBERTH SC2 App**.
- ◆ **Voice command** performance may vary based on the environmental conditions including riding speed, helmet type, and ambient noise.

11. FUNCTION PRIORITY

11.1 Function Priority

The headset prioritizes connected devices in the following order:

(highest) Mobile phone
 Mesh Intercom/Bluetooth Intercom
 Music sharing via Bluetooth stereo
 FM radio

(lowest) Bluetooth stereo music

A lower-priority function gets interrupted by a higher-priority function. For example, stereo music will be interrupted by an **Intercom Conversation**; an **Intercom Conversation** will be interrupted by an incoming mobile phone call.

12. CONFIGURATION SETTING

12.1 Headset Configuration Setting

Access the Configuration Menu

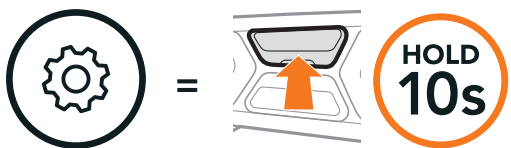

Navigate Between Menu Options

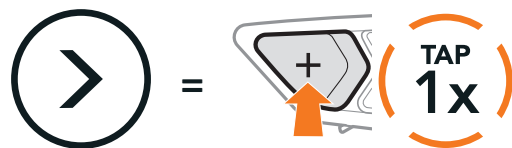

Execute Menu Options

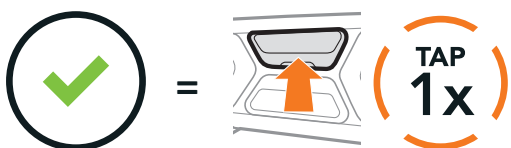

Headset Configuration Menu

Voice Configuration Menu	Tap the Center Button
Phone Pairing	None
Second Mobile Phone Pairing	None
Phone Selective Pairing	None
Media Selective Pairing	None
GPS Pairing	None
Delete All Pairings	Execute
Universal Intercom Pairing	Execute
Factory Reset	Execute
Exit	Execute

12.1.1 Delete All Pairings

Delete All Bluetooth Pairing Information stored in the headset.

12.2 Software Configuration Setting

You can change the settings of the headset through the **SCHUBERTH Device Manager** or the **SCHUBERTH SC2 App**.

12.2.1 Speed Dial

Assign phone numbers for speed dialing to make a phone call quickly.

12.2.2 Headset Language

You can select the device language. The selected language is maintained even when the headset is rebooted.

12.2.3 Audio Equalizer (Default: Off)

You can use the **Audio Equalizer** to increase/decrease the decibel level of different frequency ranges of audio.

- ◆ **Balance** will adjust all of the frequency ranges to be the same volume level (0 dB).
- ◆ **Bass Boost** will increase the bass range of audio (20 Hz - 250 Hz).
- ◆ **Mid Boost** will increase the mid range of audio (250 Hz - 4 kHz).
- ◆ **Treble Boost** will increase the high range of audio (4 kHz - 20 kHz).

12.2.4 VOX Phone (Default: Enable)

If this feature is enabled, you can answer incoming calls by voice. When you hear a ringtone for an incoming call, you can answer the phone by saying a word such as “**Hello**” loudly or by blowing air into the microphone. **VOX Phone** is temporarily disabled if you are connected to intercom. If this feature is disabled, you have to tap the **Center Button** to answer an incoming call.

12.2.5 VOX Intercom (Default: Disable)

If **VOX Intercom** is enabled, you can initiate an intercom conversation with the last connected intercom friend by voice. When you want to start intercom, say a word such as “**Hello**” loudly or blow air into the microphone. If you start an intercom conversation by voice, the intercom terminates automatically when you and your intercom friend remain silent for 20 seconds. However, if you manually start an intercom conversation by tapping the **Center Button**, you have to terminate the intercom conversation manually. However, if you start the intercom by voice and end it manually by tapping the **Center Button**, you will not be able to start intercom by voice temporarily. In this case, you have to tap the **Center Button** to restart the intercom. This is to prevent repeated unintentional intercom connections by strong wind noise. After rebooting the headset, you can start the intercom by voice again.

12.2.6 VOX Sensitivity (Default: 3)

VOX Sensitivity can be adjusted depending on your riding environment. **Level 5** is the highest sensitivity setting and **level 1** is the lowest.

12.2.7 Bluetooth Intercom Audio Multitasking (Default: Disabled)

Audio Multitasking (Bluetooth Intercom Audio Multitasking and Mesh Intercom Audio Multitasking) allows you to have an intercom conversation while simultaneously listening to music, FM radio, or GPS instructions. The overlaid audio is played in the background with reduced volume whenever there is an intercom conversation and will return to normal volume once the conversation is finished.

The **Mesh Intercom Audio Multitasking** feature is always **on**.

Note:

- ◆ For **Bluetooth Intercom Audio Multitasking** to work properly, you need to power the headset off and on. **Please restart the headset.**
- ◆ **Bluetooth Intercom Audio Multitasking** will be activated during two-way intercom conversations with a headset that also supports this feature.
- ◆ Some GPS devices may not support this feature.
- ◆ The **Audio Multitasking** feature can be configured through the **Intercom-Audio Overlay Sensitivity** and the **Audio Overlay Volume Management settings**.

12.2.8 Intercom-Audio Overlay Sensitivity (Default: 3)

The music, FM radio, and GPS volume will be lowered to play in the background if you talk over the intercom while the overlaid audio is playing. You can adjust the intercom sensitivity to activate this background audio mode. **Level 1** has the lowest sensitivity and **level 5** has the highest sensitivity.

Note: If your voice is not louder than the sensitivity of the selected level, the overlaid audio will not be lowered.

12.2.9 Audio Overlay Volume Management (Default: Disable)

The music, FM radio, and GPS overlaid audio reduces in volume whenever there is an ongoing intercom conversation. If **Audio Overlay Volume Management** is enabled, the volume level of the overlaid audio will not be reduced during an intercom conversation.

12.2.10 HD Intercom (Default: Enable)

HD Intercom enhances the two-way intercom audio from normal quality to HD quality. **HD Intercom** will become temporarily disabled when you enter into a multi-way intercom. If this feature is disabled, the two-way intercom audio will change to normal quality.

Note:

- ◆ The intercom distance of **HD Intercom** is relatively shorter than that of normal intercom.
- ◆ **HD Intercom** will become disabled temporarily when **Bluetooth Intercom Audio Multitasking** is enabled.

12.2.11 HD Voice (Default: Enable)

HD Voice allows you to communicate in high-definition during phone calls. This feature increases the quality so that the audio will be crisp and clear during phone call conversations.

If this feature is enabled, incoming phone calls will interrupt intercom conversations and audio from the SR10 will not be heard during intercom conversations. Three-Way Conference Phone Call with Intercom Participant will not be available if **HD Voice** is enabled.

Note:

- ◆ Refer to the manufacturer of your Bluetooth device that will be connected to the headset to see if it supports **HD Voice**.
- ◆ **HD Voice** is active only when **Bluetooth Intercom Audio Multitasking** is disabled.

12.2.12 Smart Volume Control (Default: Disable)

Enabling **Smart Volume Control** automatically changes the level of the speaker volume based on the level of the environment noise. You can enable it by setting the sensitivity to **low**, **medium**, or **high**.

12.2.13 Sidetone (Default: Disable)

Sidetone is audible feedback of your own voice. It helps you to naturally speak at the correct level according to varying helmet noise conditions. If this feature is enabled, you can hear what you are speaking during an intercom conversation or a phone call.

12.2.14 Voice Prompt (Default: Enable)

You can disable voice prompts by software configuration settings, but the following voice prompts are always on.

- Headset configuration settings menu, battery level indicator, speed dial, FM radio functions

12.2.15 RDS AF Setting (Default: Disable)

Radio Data System (RDS) Alternative Frequency (AF) Setting allows a receiver to re-tune to the second frequency location when the first signal becomes too weak. With RDS AF enabled on the receiver, a radio station with more than one frequency can be used.

12.2.16 FM Station Guide (Default: Enable)

When **FM Station Guide** is enabled, FM station frequencies are given by voice prompts as you select preset stations. When **FM Station Guide** is disabled, the voice prompts on FM station frequencies will not be given as you select preset stations.

12.2.17 Advanced Noise Control™ (Default: Enable)

When **Advanced Noise Control** is enabled, the background noise is reduced during an intercom conversation. When it is disabled, the background noise is mixed with your voice during intercom.

13. TROUBLESHOOTING

13.1 SC2 Factory Reset

To erase all of your settings and start fresh, the headset can be restored to factory default settings using the **Factory Reset** feature.

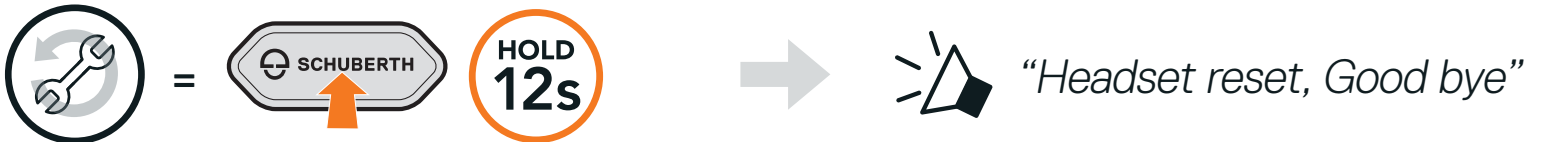

13.2 SC2 Remote Control Factory Reset

To erase all of your settings and start fresh, the **SC2 Remote Control** can be restored to factory default settings using the **Factory Reset** feature.

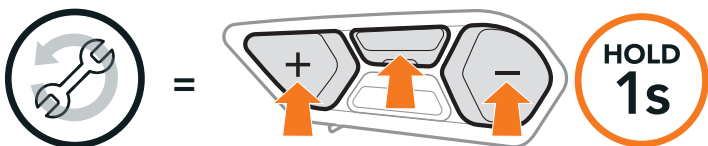

13.3 Remote Control Pairing

The **SC2** and the **SC2 Remote Control** come paired together.

They will automatically connect to each other when the **SC2** and the **SC2 Remote Control** are powered on.

If you are using a **SC2 Remote Control** other than the one included in the package, follow the procedure below to pair the **SC2** and the **SC2 Remote Control**.

1. On the **SC2**, press and hold the **Multi-function Button** for **5 seconds**.



2. On your **SC2 Remote Control**, press and hold the **(+) Button** for **8 seconds** to enter Bluetooth-pairing mode.



- The **SC2** will automatically perform pairing with the **SC2 Remote Control** in pairing mode.

When they are successfully connected, you will hear a voice prompt.



“Remote control connected”

13.4 SC2 Fault Reset

When the headset is not working properly, you can easily reset the unit.

- Remove the installed **SC2** from the helmet by lifting it up with the SC2 Remote Control cover.

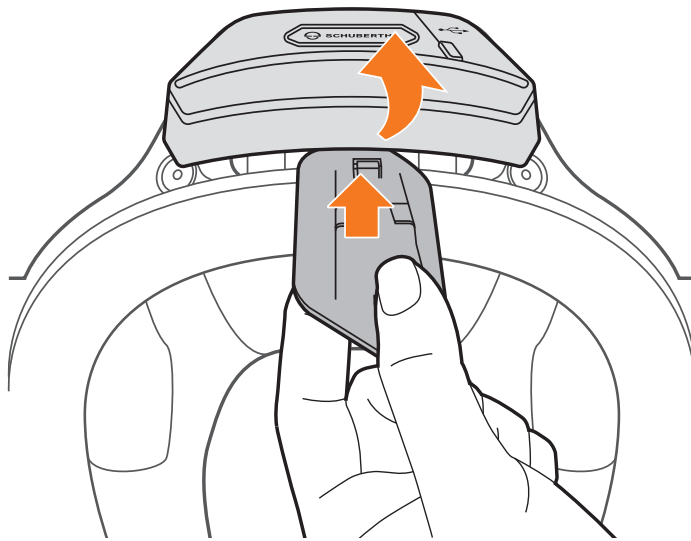

- Pull the antenna cable retainer out from its original position, and pull out the connected cables from the upper gap in the space.

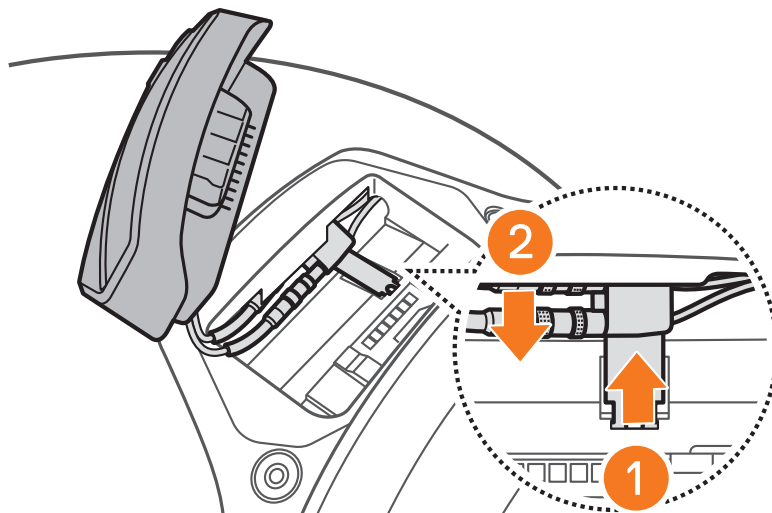

Note: You can reset the **SC2** without disconnecting the cables from the helmet.

- Locate the **Pinhole Fault Reset Button** on the back of the **SC2**.

4. Gently insert a paperclip into the hole and tap the **Pinhole Fault Reset Button** with light pressure.

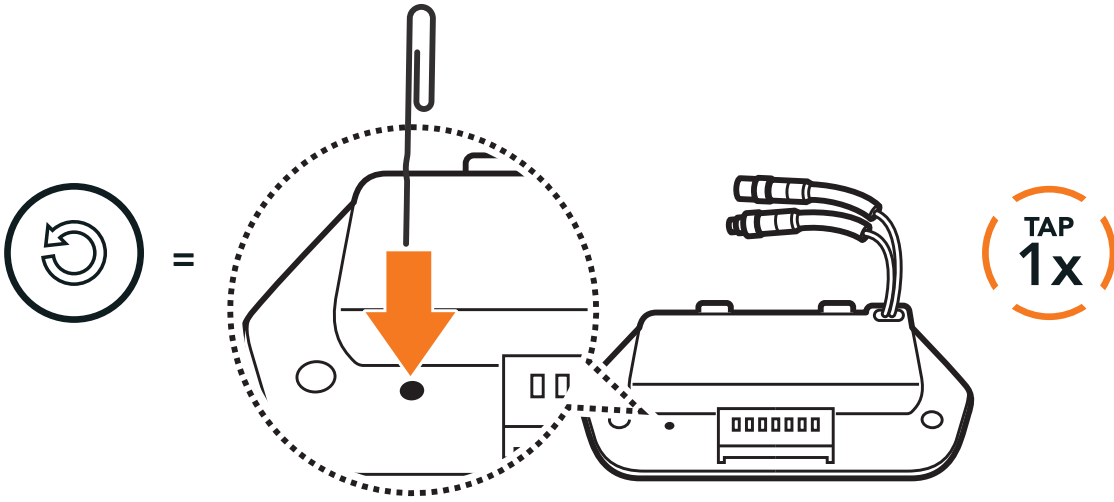

5. The headset will shut down.

Note: Fault Reset will not restore the headset to factory default settings.

Producer: Sena Technologies, Inc
19, Heolleung-ro 569-gil, Gangnam-gu
Seoul 06376, Republic of Korea

Importer in Europe: SCHUBERTH GmbH
Stegelitzer Straße 12
D-39126 Magdeburg, Germany

Importer in US: SCHUBERTH North America
9920 Pacific Heights Blvd., Suite 150
San Diego, CA 92121

WWW.SCHUBERTH.COM